



- 产品易于拆卸和重新固定。
- 不同管径压力从真空至6000psi (413bar)。
- 可以提供各种国际标准的材料和形式可选。
- 连接尺寸范围：1/8 " ~1 " 或2~25mm的卡套管，其它尺寸可定制。

卡套管接头

安装说明

1 in./25 mm及以下的尼克福斯卡套管接头

以下说明既适用于传统接头也适用于具有先进的后卡套几何形状的接头。

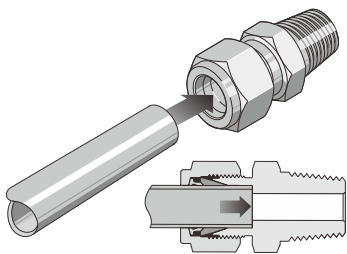

将卡套管完全插入接头内并顶住肩部；用手指紧固螺母。

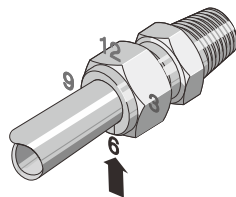

在6点钟的位置给螺母作标志。

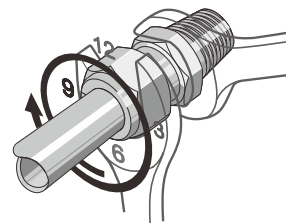

牢牢固定接头本体，将螺母紧固一又四分之一圈以停在9点钟的位置。对于1/16、1/8和3/16in.；2、3和4mm的卡套管接头，将螺母紧固四分之三圈以停在3点钟的位置。

高压应用和高安全系数系统中的安装

把卡套管完全插入接头内并顶住肩部；用手指将螺母拧紧。由于卡套管直径存在差异，需要有一个通用的起始点。因此，把螺母紧固使管子无法用手转动或无法沿轴向在接头内移动。

超过1 in./25 mm的尼克福斯卡套管接头

- 1.用预装装置将卡套预先安装到卡套管上。
- 2.在卡套完成预装后用手指拧紧螺母，并再转动半圈。
- 3.在6点钟的位置给螺母作标志。
- 4.牢牢固定接头本体，将螺母紧固二分之一圈以停在12点钟的位置。

复装——所有尺寸

您可以多次反复拆卸和复装尼克福斯卡套管接头。

- 1.把带有预装卡套的卡套管插入接头本体直到前卡套到位(图1)。
- 2.用扳手把螺母旋转到先前紧固的位置；在这一点将会遇到明显增大的阻力。
- 3.用扳手稍稍紧固(图2)。



材料

材料	棒材	锻件
316不锈钢	ASTM A276, ASME SA479, EN 1.4401	ASTM A182, ASME SA182, EN 1.4401
304不锈钢	ASTM A76, ASME SA479, EN 1.4401	ASTM A182, ASME SA182, EN 1.4401
合金 20	ASTM B473	ASTM B462
合金400	ASTM B164,	ASTM B564, ASME SB564
合金600	ASTM B166, ASME SB166	ASTM B564, ASME SB564
铝	ASTM B211	ASTM B247
黄铜	ASTM B16, ASTM B453	ASTM B283
碳钢	ASTM A108	—
PTFE	ASTM D1710	ASTM D3294

压力额定值

压力额定值以环境温度下的ASME 压力管道标准B31.3, 工艺管道为基础。

NPT/ ISO 尺寸 in.	316 SS 和碳钢				黄铜			
	外螺纹		内螺纹		外螺纹		内螺纹	
	psig	bar	psig	bar	psig	bar	psig	bar
1/16	11 000	760	6700	460	5500	380	3300	230
1/8	10 000	690	6500	440	5000	340	3200	220
1/4	8 000	550	6600	450	4000	270	3300	220
3/8	7 800	540	5300	360	3900	270	2600	180
1/2	7 700	530	4900	330	3800	260	2400	160
3/4	7 300	500	4600	330	3600	250	2300	160
1	5 300	370	4400	320	2600	180	2200	150
1-1/4	6 000	410	5000	350	3000	200	2500	170

■ 根据ASME B 1.1, 确定动力管线的压力额定值:

■ 不锈钢材料 —— 乘以 0.94

■ 碳钢材料 —— 乘以 0.85。

黄铜材料压力额定值保持不变。

■ 将 bar 乘以 0.10 得 MPa。

容许应力

应力值以环境温度下的ASME 压力管道标准 B31.3, 工艺管道为基础。

材料	容许应力	
	psi	bar
316 SS	20 000	1378
304 SS	20 000	1378
黄铜	10 000	689
钢	20 000	1378

螺纹规格

螺纹类型 (端接)	参考标准
NPT	ASME B1.20.1, SAE AS71051
ISO/BSP (平行) (根据 DIN 3852) (尼克福斯G螺纹)	ISO 228, JIS B0202
ISO/BSP (锥形) (根据 DIN 3852) (尼克福斯R螺纹)	ISO 7, BS EN 10226-1, JIS B0203
ISO/BSP (压力表) (根据 EN 837-1 and 837-3) (尼克福斯G 螺纹)	ISO 228, JIS B0202
统一标准螺纹 (SAE) (尼克福斯S螺纹)	ASME B1.1

















































SAE/MS接头压力额定值以SAE J1926/3为基础。

SAE/MS 螺纹尺寸	代号	316 SS 和碳钢			
		不可定位		可定位	
		psig	bar	psig	bar
5/16-24	S5	4568	315	4568	315
7/16-20	S7				
1/2-20	S8				
9/16-18	S9				
3/4-16	S12				
7/8-14	S14	3626	250	2900	200
1 1/16-1	S17				
1 3/16-1	S19	2900	200	2320	160
1 5/16-1	S21				
1 5/8-1	S26				
1 7/8-1	S30	2320	160	1813	125
2 1/2-1	S40				
		1813	125	1450	100

一些使用 AN、O型圈密封和 SAE/MS末端的接头压力额定值可能较低。如需更详细信息, 请与您授权的尼克福斯代表联系。

卡套管接头

● 卡套管接头

	卡套螺母	6		卡套直角接头	24
	前卡套芯	6		NPT外螺纹卡套直角接头	24
	后卡套芯	6		ISO/BSP锥形外螺纹卡套直角接头	26
	卡套直通接头	7		SAE/MS平行螺纹可定位卡套直角接头	26
	卡套直通异径接头	7		NPT内螺纹卡套直角接头	27
	NPT外螺纹直通终端接头	9		卡套管承插焊卡套直角接头	27
	ISO/BSP锥形外螺纹直通终端接头	11		公称管焊接卡套直角接头	28
	ISO/BSP平行外螺纹直通终端接头	12		NPT外螺纹卡套45°弯头	28
	SAE/MS平行外螺纹直通终端接头	14		SAE/MS平行螺纹可定位卡套45°弯头	28
	米制外螺纹直通终端接头	14		卡套三通接头	29
	NPT内螺纹卡套直通接头	15		卡套三通异径接头	29
	ISO/BSP锥形内螺纹卡套直通接头	16		NPT外螺纹支管三通	29
	ISO/BSP平行内螺纹卡套直通接头	16		ISO/BSP锥形外螺纹支管三通	30
	卡套管承插焊直通终端接头	17		NPT外螺纹侧三通	30
	公称管焊接直通终端接头	17		ISO/BSP锥形外螺纹侧三通	31
	卡套转卡套短管直通接头	18		NPT内螺纹支管三通	31
	37°扩口卡套直通终端接头	20		ISO/BSP锥形内螺纹支管三通	31
	卡套直通穿板接头	20		NPT内螺纹侧三通	32
	NPT外螺纹卡套直通穿板接头	21		ISO/BSP锥形内螺纹侧三通	32
	NPT内螺纹卡套直通穿板接头	21		卡套四通接头	32
	卡套转卡套短管直通穿板接头	22		卡套转法兰接头	33
	37°扩口卡套直通穿板接头	22		卡套转卫生级法兰接头	33
	卡套短管外螺纹直通接头	22		管堵	34
	卡套短管内螺纹直通接头	23		卡套堵头	34

SS — U — C8M — TF4

1 2 3 4

1 材料

SS	316
S	304
SL	316L
SC	碳钢
C	A105碳料
B	黄铜
M2	合金20
M4	合金400
M6	合金600
T	PTFE

2 系列

U	直通接头
L	90度直角接头
V	45度接头
T	三通接头
H	四通接头
HJ	活接接头
GD	管堵
GM	卡套堵头
BU	直通穿板接头
PF	排放保护器
CA	前卡套芯
CB	后卡套芯
CM	卡套螺母

3 端口形式

C	双卡套端
T	NPT外螺纹
TF	NPT内螺纹
G	ISO平行外螺纹
GF	ISO平行内螺纹
GR	压力表接头
R	ISO锥形外螺纹/ZG
RC	ISO锥形内螺纹/ZGF
S	UN统一外螺纹/SAE/MS
SF	UN统一内螺纹/SAE/MS
M	米制外螺纹
MF	米制内螺纹
DWP	Pipe公称管对焊
CWP	Pipe公称管承插焊
DWT	Tube管对焊
CWT	Tube管承插焊
P	卡套短管
A	软管接口(宝塔接口)
AN	37° 外螺纹扩口
ANF	37° 内螺纹扩口
VS	卫生法兰接口
FL	法兰接口

4 端口尺寸

1	= 1/16"	2M	= 2mm
2	= 1/8"	3M	= 3mm
3	= 3/16"	6M	= 6mm
4	= 1/4"	8M	= 8mm
5	= 5/16"	10M	= 10mm
6	= 3/8"	12M	= 12mm
7	= 7/16"	14M	= 14mm
8	= 1/2"	15M	= 15mm
9	= 9/16"	16M	= 16mm
10	= 5/8"	18M	= 18mm
11	= 11/16"	19M	= 19mm
12	= 3/4"	20M	= 20mm
13	= 13/16"	22M	= 22mm
14	= 7/8"	25M	= 25mm
15	= 15/16"	28M	= 28mm
16	= 1"	32M	= 32mm
20	= 1 1/4"		

端口为UN统一螺纹时(S/SF)

2	= 5/16-24
4	= 7/16-20
5	= 1/2-20
6	= 9/16-18
8	= 3/4-16
10	= 7/8-14
12	= 1 1/16-12
14	= 1 3/16-12
16	= 1 5/16-12
20	= 1 5/8-12
24	= 1 7/8-12
32	= 2 1/2-12

端口为米制螺纹时(M/MF)

8	= M8X1
10	= M10X1
12	= M12X1.5
14	= M14X1.5
16	= M16X1.5
18	= M18X1.5
20	= M20X1.5
22	= M22X1.5
24	= M24X1.5
27	= M27X2
30	= M30X2
33	= M33X2

非上述螺纹型号中应注明螺距列：

20X2	= M20X2
27X1.5	= M27X1.5

完整的尼克福斯接头型号编码，应包含：材料、系列、第一端口、第二端口四个部分,从左向右，各部分之间以“-”分隔。

端口之间的排列顺序原则：

- 1、第一端口优先使用卡套端，其次为螺纹、焊接、法兰。
- 2、两端口形式代码相同时，以公制尺寸的端口优先；为同种螺纹时，以外螺纹优先；同为焊接时，以公制管焊接优先，其次是英制Tube管焊接，最后是Pipe管焊接。
- 3、按1、2原则优先顺序相同的，以端口尺寸大的作为第一端口。
- 4、当直通或三通或四通端口完全相同时，以任意一个作为第一端口，并省略后面的端口。
- 5、三通和四通的订购号首先表示直通的尺寸1至2,然后是支管的尺寸三通的3或四通的3至4。

例：SS-T-C6M-T4-C6M,表示一个1和3口为6mm卡套2口为1/4NPT内螺纹316三通接头

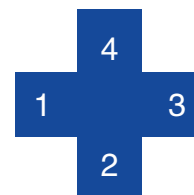

卡套管接头

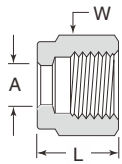

卡套螺母(公制)

基本订购号	导管外径A (mm)	六角W (mm)	长度L (mm)
-CM2M	2	12	11.9
-CM3M	3	12	11.9
-CM4M	4	12	11.9
-CM6M	6	14	12.7
-CM8M	8	16	13.5
-CM10M	10	19	15.1
-CM12M	12	22	17.4
-CM14M	14	25	17.4
-CM15M	15	25	17.4
-CM16M	16	25	17.4
-CM18M	18	30	17.4
-CM20M	20	32	17.4
-CM22M	22	32	17.4
-CM25M	25	38	20.6

卡套螺母(英制)

基本订购号	导管外径A (in)	六角W (in)	长度L (in)
-CM1	1/16	5/16	0.31
-CM2	1/8	7/16	0.47
-CM3	3/16	1/2	0.47
-CM4	1/4	9/16	0.50
-CM5	5/16	5/8	0.53
-CM6	3/8	11/16	0.56
-CM8	1/2	7/8	0.69
-CM10	5/8	1	0.69
-CM12	3/4	1 1/8	0.69
-CM14	7/8	1 1/4	0.69
-CM16	1	1 1/2	0.81

前卡套芯(公制)

基本订购号	导管外径A (mm)
-CA2M	2
-CA3M	3
-CA4M	4
-CA6M	6
-CA8M	8
-CA10M	10
-CA12M	12
-CA14M	14
-CA15M	15
-CA16M	16
-CA18M	18
-CA20M	20
-CA22M	22
-CA25M	25

前卡套芯(英制)

基本订购号	导管外径A (in)
-CA1	1/16
-CA2	1/8
-CA3	3/16
-CA4	1/4
-CA5	5/16
-CA6	3/8
-CA8	1/2
-CA10	5/8
-CA12	3/4
-CA14	7/8
-CA16	1

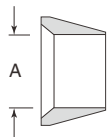

后卡套芯(公制)

基本订购号	导管外径A (mm)
-CB2M	2
-CB3M	3
-CB4M	4
-CB6M	6
-CB8M	8
-CB10M	10
-CB12M	12
-CB14M	14
-CB15M	15
-CB16M	16
-CB18M	18
-CB20M	20
-CB22M	22
-CB25M	25

后卡套芯(英制)

基本订购号	导管外径A (in)
-CB1	1/16
-CB2	1/8
-CB3	3/16
-CB4	1/4
-CB5	5/16
-CB6	3/8
-CB8	1/2
-CB10	5/8
-CB12	3/4
-CB14	7/8
-CB16	1

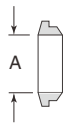

卡套直通中间接头(公制)

基本订购号	导管外径A (mm)	孔径D (mm)	六角W (mm)	长度L (mm)
-U-C2M	2	1.7	12	35.6
-U-C3M	3	2.4	12	35.3
-U-C4M	4	2.4	12	37.3
-U-C6M	6	4.8	14	41.0
-U-C8M	8	6.4	15	43.2
-U-C10M	10	7.9	18	46.2
-U-C12M	12	9.5	22	51.2
-U-C14M	14	11.1	24	52.0
-U-C15M	15	11.9	24	52.0
-U-C16M	16	12.7	24	52.0
-U-C18M	18	15.1	27	53.5
-U-C20M	20	15.9	30	55.0
-U-C22M	22	18.3	30	55.0
-U-C25M	25	21.8	35	65.0

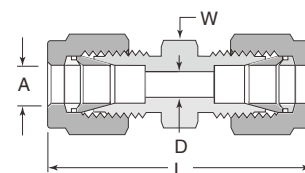

卡套直通中间接头(英制)

基本订购号	导管外径A (in)	孔径D (in)	六角W (in)	长度L (in)
-U-C1	1/16	0.05	5/16	0.99
-U-C2	1/8	0.09	7/16	1.40
-U-C3	3/16	0.12	7/16	1.47
-U-C4	1/4	0.19	1/2	1.61
-U-C5	5/16	0.25	9/16	1.69
-U-C6	3/8	0.28	5/8	1.77
-U-C8	1/2	0.41	13/16	2.02
-U-C10	5/8	0.50	15/16	2.05
-U-C12	3/4	0.62	1 1/16	2.11
-U-C14	7/8	0.72	1 3/16	2.17
-U-C16	1	0.88	1 3/8	2.55

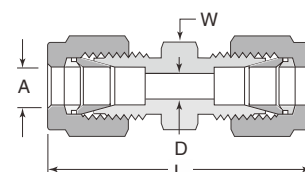

卡套直通异径接头(公制)

基本订购号	导管外径A (mm)	导管外径A1 (mm)	孔径D (mm)	六角W (mm)	长度L (mm)
-U-C3M-C2M	3	2	1.7	12	35.3
-U-C6M-C2M	6	2	1.7	14	38.6
-U-C6M-C3M	6	3	2.4	14	38.6
-U-C6M-C4M	6	4	2.4	14	39.4
-U-C8M-C6M	8	6	4.8	15	42.3
-U-C10M-C6M	10	6	4.8	18	44.5
-U-C10M-C8M	10	8	6.4	18	45.1
-U-C12M-C6M	12	6	4.8	22	47.0
-U-C12M-C8M	12	8	6.4	22	47.8
-U-C12M-C10M	12	10	7.9	22	48.7
-U-C16M-C10M	16	10	7.9	24	49.5
-U-C16M-C12M	16	12	9.5	24	52.0
-U-C18M-C12M	18	12	9.5	27	53.5
-U-C25M-C18M	25	18	15.1	35	61.0
-U-C25M-C20M	25	20	15.9	35	62.3

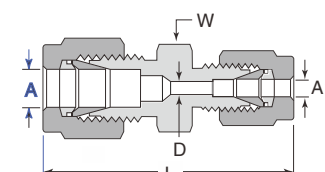

卡套管接头

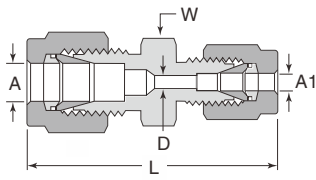

卡套直通异径接头(英制)

基本订购号	导管外径A (in)	导管外径A1 (in)	孔径D (in)	六角W (in)	长度L (in)
-U-C2-C1	1/8	1/16	0.05	7/16	1.22
-U-C3-C1	3/16	1/16	0.05	7/16	1.27
-U-C3-C2	3/16	1/8	0.09	7/16	1.44
-U-C4-C1	1/4	1/16	0.05	1/2	1.35
-U-C4-C2	1/4	1/8	0.09	1/2	1.52
-U-C4-C3	1/4	3/16	0.12	1/2	1.55
-U-C5-C2	5/16	1/8	0.09	9/16	1.56
-U-C5-C4	5/16	1/4	0.19	9/16	1.66
-U-C6-C1	3/8	1/16	0.05	5/8	1.44
-U-C6-C2	3/8	1/8	0.09	5/8	1.61
-U-C6-C4	3/8	1/4	0.19	5/8	1.70
-U-C6-C5	3/8	5/16	0.25	5/8	1.74
-U-C8-C2	1/2	1/8	0.09	13/16	1.78
-U-C8-C4	1/2	1/4	0.19	13/16	1.85
-U-C8-C6	1/2	3/8	0.28	13/16	1.91
-U-C10-C6	5/8	3/8	0.28	15/16	1.94
-U-C10-C8	5/8	1/2	0.41	15/16	2.05
-U-C12-C4	3/4	1/4	0.19	1 1/16	1.94
-U-C12-C6	3/4	3/8	0.28	1 1/16	2.00
-U-C12-C8	3/4	1/2	0.41	1 1/16	2.11
-U-C12-C10	3/4	5/8	0.50	1 1/16	2.11
-U-C16-C8	1	1/2	0.41	1 3/8	2.38
-U-C16-C12	1	3/4	0.62	1 3/8	2.38

卡套直通异径接头(公制转英制)

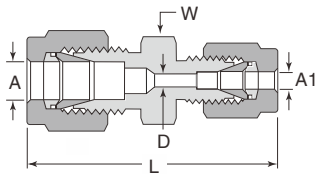

基本订购号	导管外径A (mm)	导管外径A1 (in)	孔径D (mm)	六角W (mm)	长度L (mm)
-U-C2M-C4	2	1/4	1.7	14	38.6
-U-C3M-C2	3	1/8	2.4	12	35.2
-U-C4M-C2	4	1/8	2.4	12	36.5
-U-C4M-C4	4	1/4	2.4	14	39.4
-U-C6M-C2	6	1/8	2.4	14	38.5
-U-C6M-C4	6	1/4	4.8	14	41.0
-U-C6M-C5	6	5/16	4.8	14	42.3
-U-C8M-C4	8	1/4	4.8	15	42.3
-U-C8M-C6	8	3/8	6.4	16	44.3
-U-C10M-C2	10	1/8	2.4	18	41.8
-U-C10M-C4	10	1/4	4.8	18	44.5
-U-C10M-C5	10	5/16	6.4	18	45.1
-U-C10M-C6	10	3/8	7.1	18	45.9
-U-C12M-C4	12	1/4	4.8	22	47.0
-U-C12M-C5	12	5/16	6.4	22	47.8
-U-C12M-C6	12	3/8	7.1	22	48.4
-U-C12M-C8	12	1/2	9.5	22	51.2
-U-C15M-C8	15	1/2	10.3	24	52.0
-U-C16M-C10	16	5/8	12.7	24	52.0
-U-C18M-C12	18	3/4	15.1	27	53.5
-U-C20M-C8	20	1/2	10.3	30	55.0
-U-C20M-C16	20	1	15.9	35	62.8
-U-C25M-C16	25	1	21.8	35	65.0

NPT外螺纹直通终端接头(英制)

基本订购号	导管外径A (in)	外螺纹T (NPT)	孔径D (in)	六角W (in)	长度L (in)
-U-C1-T1	1/16	1/16	0.05	5/16	0.94
-U-C1-T2	1/16	1/8	0.05	7/16	1.03
-U-C1-T4	1/16	1/4	0.05	9/16	1.22
-U-C2-T1	1/8	1/16	0.09	7/16	1.17
-U-C2-T2	1/8	1/8	0.09	7/16	1.20
-U-C2-T4	1/8	1/4	0.09	9/16	1.40
-U-C2-T6	1/8	3/8	0.09	11/16	1.41
-U-C2-T8	1/8	1/2	0.09	7/8	1.66
-U-C3-T2	3/16	1/8	0.12	7/16	1.23
-U-C3-T4	3/16	1/4	0.12	9/16	1.43
-U-C4-T1	1/4	1/16	0.12	1/2	1.29
-U-C4-T2	1/4	1/8	0.19	1/2	1.29
-U-C4-T4	1/4	1/4	0.19	9/16	1.49
-U-C4-T6	1/4	3/8	0.19	11/16	1.51
-U-C4-T8	1/4	1/2	0.19	7/8	1.76
-U-C4-T12	1/4	3/4	0.19	1 1/16	1.82
-U-C5-T2	5/16	1/8	0.19	9/16	1.34
-U-C5-T4	5/16	1/4	0.25	9/16	1.52
-U-C5-T6	5/16	3/8	0.25	11/16	1.54
-U-C6-T2	3/8	1/8	0.19	5/8	1.39
-U-C6-T4	3/8	1/4	0.28	5/8	1.57
-U-C6-T6	3/8	3/8	0.28	11/16	1.57
-U-C6-T8	3/8	1/2	0.28	7/8	1.82
-U-C6-T12	3/8	3/4	0.28	1 1/16	1.88
-U-C6-T16	3/8	1	0.28	1 3/8	1.85
-U-C8-T2	1/2	1/8	0.19	13/16	1.53
-U-C8-T4	1/2	1/4	0.28	13/16	1.71
-U-C8-T6	1/2	3/8	0.38	13/16	1.71
-U-C8-T8	1/2	1/2	0.41	7/8	1.93
-U-C8-T12	1/2	3/4	0.41	1 1/16	1.99
-U-C8-T16	1/2	1	0.41	1 3/8	2.25
-U-C10-T4	5/8	1/4	0.28	15/16	1.74
-U-C10-T6	5/8	3/8	0.38	15/16	1.74
-U-C10-T8	5/8	1/2	0.47	15/16	1.93
-U-C10-T12	5/8	3/4	0.50	1 1/16	1.99
-U-C12-T6	3/4	3/8	0.41	1 1/16	1.80
-U-C12-T8	3/4	1/2	0.47	1 1/16	1.99
-U-C12-T12	3/4	3/4	0.62	1 1/16	1.99
-U-C12-T16	3/4	1	0.62	1 3/8	2.25
-U-C14-T8	7/8	1/2	0.47	1 3/16	1.99
-U-C14-T12	7/8	3/4	0.62	1 3/16	1.99
-U-C14-T16	7/8	1	0.72	1 3/8	2.25
-U-C16-T8	1	1/2	0.47	1 3/8	2.26
-U-C16-T12	1	3/4	0.62	1 3/8	2.26
-U-C16-T16	1	1	0.88	1 3/8	2.45

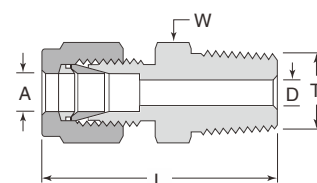

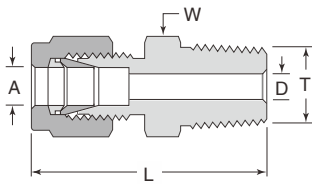

NPT外螺纹直通终端接头(公制)

基本订购号	导管外径A (mm)	外螺纹T (NPT)	孔径D (mm)	六角W (mm)	长度L (mm)
-U-C2M-T2	2	1/8	1.7	12	30.5
-U-C3M-T2	3	1/8	2.4	12	30.5
-U-C3M-T4	3	1/4	2.4	14	35.6
-U-C4M-T2	4	1/8	2.4	12	31.2
-U-C4M-T4	4	1/4	2.4	14	36.3
-U-C6M-T2	6	1/8	4.8	14	32.8
-U-C6M-T4	6	1/4	4.8	14	37.9
-U-C6M-T6	6	3/8	4.8	18	38.4
-U-C6M-T8	6	1/2	4.8	22	44.7
-U-C8M-T2	8	1/8	4.8	15	34.2
-U-C8M-T4	8	1/4	6.4	15	38.7
-U-C8M-T6	8	3/8	6.4	18	39.3
-U-C8M-T8	8	1/2	6.4	22	45.6
-U-C10M-T2	10	1/8	4.8	18	36.3
-U-C10M-T4	10	1/4	7.1	18	40.9
-U-C10M-T6	10	3/8	7.9	18	40.9
-U-C10M-T8	10	1/2	7.9	22	46.5
-U-C10M-T12	10	3/4	7.9	27	48.0
-U-C12M-T2	12	1/8	4.8	22	38.8
-U-C12M-T4	12	1/4	7.1	22	43.4
-U-C12M-T6	12	3/8	9.5	22	43.4
-U-C12M-T8	12	1/2	9.5	22	49.0
-U-C12M-T12	12	3/4	9.5	27	50.5
-U-C14M-T4	14	1/4	7.1	24	44.1
-U-C14M-T6	14	3/8	9.5	24	44.1
-U-C14M-T8	14	1/2	11.1	24	49.0
-U-C15M-T8	15	1/2	11.9	24	49.0
-U-C16M-T6	16	3/8	9.5	24	44.1
-U-C16M-T8	16	1/2	11.9	24	49.0
-U-C16M-T12	16	3/4	12.7	27	50.5
-U-C18M-T8	18	1/2	11.9	27	50.5
-U-C18M-T12	18	3/4	15.1	27	50.5
-U-C20M-T8	20	1/2	11.9	30	52.3
-U-C20M-T12	20	3/4	15.9	30	52.3
-U-C22M-T12	22	3/4	15.9	30	52.3
-U-C22M-T16	22	1	18.3	35	57.1
-U-C25M-T8	25	1/2	11.9	35	57.5
-U-C25M-T12	25	3/4	15.9	35	57.5
-U-C25M-T16	25	1	21.8	35	62.3

参考标准:

美标管螺纹NPT

NPT是根据美国国家标准学会标准之B1.20.1部分制定的。

- 60°牙型角
- 螺距单位为每英寸牙数
- 牙根和牙顶的剖面为梯形
- 锥度1°47'

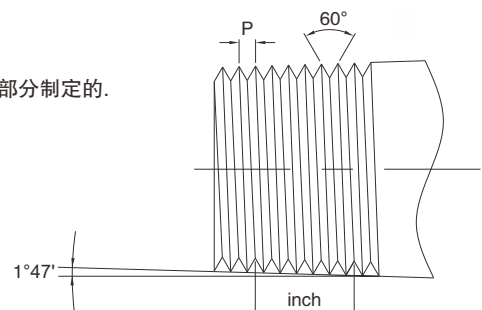

ISO/BSP锥形外螺纹直通终端接头(公制)

基本订购号	导管外径A (mm)	外螺纹T (R/BSPT)	孔径D (mm)	六角W (mm)	长度L (mm)
-U-C2M-R2	2	1/8	1.7	12	30.5
-U-C3M-R2	3	1/8	2.4	12	30.5
-U-C3M-R4	3	1/4	2.4	14	35.6
-U-C4M-R2	4	1/8	2.4	12	31.2
-U-C4M-R4	4	1/4	2.4	14	36.3
-U-C6M-R2	6	1/8	4.8	14	32.8
-U-C6M-R4	6	1/4	4.8	14	37.9
-U-C6M-R6	6	3/8	4.8	18	38.4
-U-C6M-R8	6	1/2	4.8	22	44.7
-U-C8M-R2	8	1/8	4.8	15	34.2
-U-C8M-R4	8	1/4	6.4	15	38.7
-U-C8M-R6	8	3/8	6.4	18	39.2
-U-C8M-R8	8	1/2	6.4	22	45.6
-U-C10M-R2	10	1/8	4.8	18	36.3
-U-C10M-R4	10	1/4	7.1	18	40.9
-U-C10M-R6	10	3/8	7.9	18	40.9
-U-C10M-R8	10	1/2	7.9	22	46.5
-U-C10M-R12	10	3/4	7.9	27	48.0
-U-C12M-R4	12	1/4	7.1	22	43.4
-U-C12M-R6	12	3/8	9.5	22	43.4
-U-C12M-R8	12	1/2	9.5	22	49.0
-U-C12M-R12	12	3/4	9.5	27	50.5
-U-C14M-R4	14	1/4	7.1	24	44.1
-U-C14M-R6	14	3/8	9.5	24	44.1
-U-C16M-R8	15	1/2	11.9	24	49.0
-U-C16M-R4	16	1/4	7.1	24	44.1
-U-C16M-R6	16	3/8	9.5	24	44.1
-U-C16M-R8	16	1/2	11.9	24	49.0
-U-C16M-R12	16	3/4	12.7	27	50.5
-U-C18M-R8	18	1/2	11.9	27	50.5
-U-C18M-R12	18	3/4	15.1	27	50.5
-U-C20M-R8	20	1/2	11.9	30	52.3
-U-C20M-R12	20	3/4	15.9	30	52.3
-U-C22M-R12	22	3/4	15.9	30	52.3
-U-C22M-R16	22	1	18.3	35	57.1
-U-C25M-R8	25	1/2	11.9	35	57.5
-U-C25M-R12	25	3/4	15.9	35	57.5
-U-C25M-R16	25	1	21.8	35	62.3

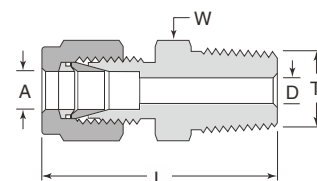

参考标准:

ISO/BSP锥形管螺纹R

GB/T-7306 (中国工业标准)

ISO - 7/1-BSP-T (国际标准化组织标准)

DIN - ISO 2999 (德国工业标准)

BS - 21 (英国国家标准学会标准)

JIS - B0203 (日本工业标准)

- 55°牙型角
- 螺距单位为每英寸牙数
- 牙根和牙顶的剖面为圆角
- 锥度1°47'

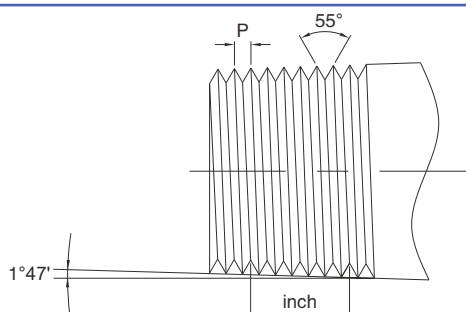

卡套管接头

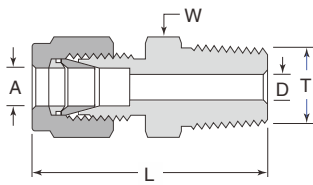

ISO/BSP锥形外螺纹直通终端接头(英制)

基本订购号	导管外径A (in)	外螺纹T (R/BSPT)	孔径D (in)	六角W (in)	长度L (in)
-U-C2-R2	1/8	1/8	0.09	7/16	1.20
-U-C2-R4	1/8	1/4	0.09	9/16	1.40
-U-C4-R2	1/4	1/8	0.19	1/2	1.29
-U-C4-R4	1/4	1/4	0.19	9/16	1.49
-U-C4-R6	1/4	3/8	0.19	11/16	1.51
-U-C4-R8	1/4	1/2	0.19	7/8	1.76
-U-C5-R2	5/16	1/8	0.19	9/16	1.34
-U-C5-R4	5/16	1/4	0.25	9/16	1.52
-U-C6-R2	3/8	1/8	0.19	5/8	1.39
-U-C6-R4	3/8	1/4	0.28	5/8	1.57
-U-C6-R6	3/8	3/8	0.28	11/16	1.57
-U-C6-R8	3/8	1/2	0.28	7/8	1.82
-U-C6-R12	3/8	3/4	0.28	1 1/16	1.88
-U-C8-R4	1/2	1/4	0.28	13/16	1.71
-U-C8-R6	1/2	3/8	0.38	13/16	1.71
-U-C8-R8	1/2	1/2	0.41	7/8	1.93
-U-C8-R12	1/2	3/4	0.41	1 1/16	1.99
-U-C10-R8	5/8	1/2	0.47	15/16	1.93
-U-C12-R12	3/4	3/4	0.62	1 1/16	1.99
-U-C12-R16	3/4	1	0.62	1 3/8	2.25
-U-C16-R12	1	3/4	0.63	1 3/8	2.26
-U-C16-R16	1	1	0.88	1 3/8	2.45

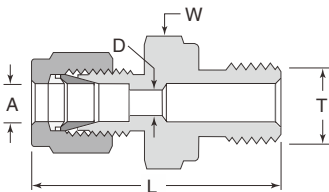

ISO/BSP平行外螺纹直通终端接头(英制)

基本订购号	导管外径A (in)	外螺纹T (G/BSPP)	孔径D (in)	六角W (in)	长度L (in)
-U-C2-G2	1/8	1/8	0.09	9/16	1.31
-U-C2-G4	1/8	1/4	0.09	3/4	1.50
-U-C2-G6	1/8	3/8	0.09	7/8	1.53
-U-C4-G2	1/4	1/8	0.16	9/16	1.40
-U-C4-G4	1/4	1/4	0.19	3/4	1.59
-U-C4-G6	1/4	3/8	0.19	7/8	1.62
-U-C4-G8	1/4	1/2	0.19	1 1/16	1.70
-U-C6-G2	3/8	1/8	0.16	5/8	1.49
-U-C6-G4	3/8	1/4	0.23	3/4	1.65
-U-C6-G6	3/8	3/8	0.28	7/8	1.68
-U-C6-G8	3/8	1/2	0.28	1 1/16	1.76
-U-C8-G4	1/2	1/4	0.23	13/16	1.76
-U-C8-G6	1/2	3/8	0.31	7/8	1.79
-U-C8-G8	1/2	1/2	0.41	1 1/16	1.87
-U-C12-G8	3/4	1/2	0.47	1 1/16	1.92
-U-C12-G12	3/4	3/4	0.62	1 5/16	2.05
-U-C16-G8	1	1/2	0.47	1 3/8	2.19
-U-C16-G12	1	3/4	0.63	1 3/8	2.27
-U-C16-G16	1	1	0.78	1 5/8	2.35

ISO/BSP平行外螺纹直通终端接头(公制)

基本订购号	导管外径A (mm)	外螺纹T (G/BSPP)	孔径D (mm)	六角W (mm)	长度L (mm)
-U-C2M-G2	2	1/8	1.7	14	33.3
-U-C3M-G2	3	1/8	2.4	14	33.3
-U-C3M-G4	3	1/4	2.4	19	38.1
-U-C4M-G2	4	1/8	2.4	14	34.0
-U-C6M-G2	6	1/8	4.0	14	35.6
-U-C6M-G4	6	1/4	4.8	19	40.4
-U-C6M-G6	6	3/8	4.8	22	41.1
-U-C6M-G8	6	1/2	4.8	27	43.2
-U-C8M-G2	8	1/8	4.0	15	36.6
-U-C8M-G4	8	1/4	6.4	19	41.4
-U-C8M-G6	8	3/8	6.4	22	42.2
-U-C8M-G8	8	1/2	6.4	27	44.2
-U-C10M-G4	10	1/4	5.9	19	42.2
-U-C10M-G6	10	3/8	7.9	22	42.9
-U-C10M-G8	10	1/2	7.9	27	45.0
-U-C12M-G4	12	1/4	5.9	22	44.5
-U-C12M-G6	12	3/8	7.9	22	45.5
-U-C12M-G8	12	1/2	9.5	27	47.5
-U-C12M-G12	12	3/4	9.5	35	52.1
-U-C14M-G6	14	3/8	7.9	24	43.9
-U-C14M-G8	14	1/2	11.1	27	47.5
-U-C15M-G6	15	3/8	7.9	24	45.5
-U-C15M-G8	15	1/2	11.9	27	47.5
-U-C15M-G12	15	3/4	11.9	35	52.8
-U-C16M-G6	16	3/8	7.9	24	45.5
-U-C16M-G8	16	1/2	11.9	27	47.5
-U-C16M-G12	16	3/4	12.7	35	52.8
-U-C18M-G8	18	1/2	11.9	27	48.8
-U-C18M-G12	18	3/4	15.1	35	52.1
-U-C20M-G8	20	1/2	11.9	30	50.5
-U-C20M-G12	20	3/4	15.9	35	52.6
-U-C22M-G12	22	3/4	15.9	35	52.6
-U-C22M-G16	22	1	18.3	41	54.9
-U-C25M-G12	25	3/4	15.9	35	57.7
-U-C25M-G16	25	1	19.8	41	59.7

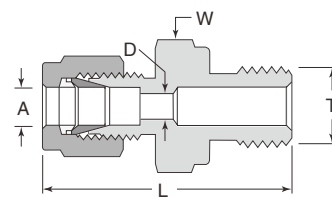

参考标准:

ISO/BSP平行管螺纹G

GB/T-7306 (中国工业标准)

ISO - 7/1-BSP-T (国际标准化组织标准)

DIN - ISO 2999 (德国工业标准)

BS - 21 (英国国家标准学会标准)

JIS - B0203 (日本工业标准)

- 55° 牙型角
- 螺距单位为每英寸牙数
- 牙根和牙顶的剖面为圆角
- 直径的尺寸单位为英寸

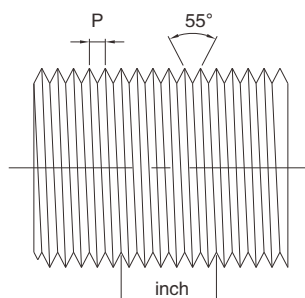

卡套管接头

SAE/MS平行外螺纹直通终端接头(英制)

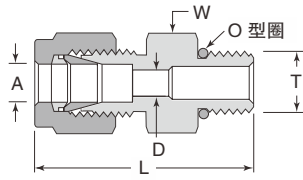

基本订购号	导管外径A (in)	外螺纹T (UN/SAE)	孔径D (in)	六角W (in)	长度L (in)
-U-C2-S2	1/8	5/16-24	0.09	7/16	1.18
-U-C2-S4	1/8	7/16-20	0.09	9/16	1.24
-U-C2-S6	1/8	9/16-18	0.09	11/16	1.31
-U-C4-S2	1/4	5/16-24	0.09	1/2	1.27
-U-C4-S4	1/4	7/16-20	0.19	9/16	1.34
-U-C4-S6	1/4	9/16-18	0.19	11/16	1.40
-U-C4-S8	1/4	3/4-16	0.19	7/8	1.48
-U-C4-S10	1/4	7/8-14	0.19	1	1.60
-U-C5-S5	5/16	1/2-20	0.25	5/8	1.37
-U-C6-S4	3/8	7/16-20	0.18	5/8	1.40
-U-C6-S6	3/8	9/16-18	0.28	11/16	1.46
-U-C6-S8	3/8	3/4-16	0.28	7/8	1.54
-U-C6-S10	3/8	7/8-14	0.28	1	1.66
-U-C8-S6	1/2	9/16-18	0.28	13/16	1.54
-U-C8-S8	1/2	3/4-16	0.41	7/8	1.65
-U-C8-S10	1/2	7/8-14	0.41	1	1.77
-U-C8-S12	1/2	1 1/16-12	0.41	1 1/4	1.93
-U-C10-S8	5/8	3/4-16	0.42	15/16	1.65
-U-C10-S10	5/8	7/8-14	0.50	1	1.78
-U-C12-S8	3/4	3/4-16	0.42	1 1/16	1.81
-U-C12-S12	3/4	1 1/16-12	0.62	1 1/4	1.93
-U-C12-S16	3/4	1 5/16-12	0.63	1 1/2	1.96
-U-C14-S14	7/8	1 3/16-12	0.72	1 3/8	1.93
-U-C16-S12	1	1 1/16-12	0.66	1 3/8	2.10
-U-C16-S16	1	1 5/16-12	0.88	1 1/2	2.14

SAE/UN平行外螺纹直通终端接头(公制)

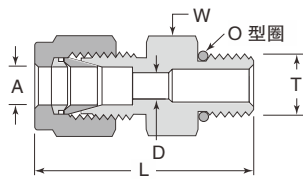

基本订购号	导管外径A (mm)	外螺纹T (SAE/UN)	孔径D (mm)	六角W (mm)	长度L (mm)
-U-C6M-S6	6	9/16-18	4.8	18	35.6
-U-C10M-S6	10	9/16-18	7.1	22	37.3
-U-C10M-S8	10	3/4-16	7.9	22	39.4
-U-C12M-S4	12	7/16-20	5.2	22	40.6
-U-C12M-S6	12	9/16-18	7.1	22	39.9

米制外螺纹直通终端接头(公制)

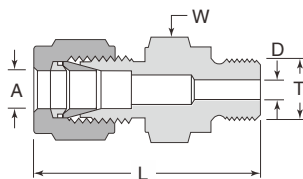

基本订购号	导管外径A (mm)	外螺纹T (M牙)	孔径D (mm)	六角W (mm)	长度L (mm)
-U-C6M-M10X1	6	M10X1	3.2	14	36.3
-U-C6M-M12X1	6	M12X1	4.8	14	40.4
-U-C12M-M16X1.5	12	M16X1.5	9.5	22	45.5

NPT内螺纹直通终端接头(英制)

基本订购号	导管外径A (in)	内螺纹T (NPT)	孔径D (in)	六角W (in)	长度L (in)
-U-C2-TF2	1/8	1/8	0.09	9/16	1.13
-U-C2-TF4	1/8	1/4	0.09	3/4	1.32
-U-C3-TF2	3/16	1/8	0.12	9/16	1.17
-U-C4-TF2	1/4	1/8	0.19	9/16	1.23
-U-C4-TF4	1/4	1/4	0.19	3/4	1.41
-U-C4-TF6	1/4	3/8	0.19	7/8	1.48
-U-C4-TF8	1/4	1/2	0.19	1 1/16	1.67
-U-C5-TF2	5/16	1/8	0.25	9/16	1.26
-U-C5-TF4	5/16	1/4	0.25	3/4	1.45
-U-C6-TF2	3/8	1/8	0.28	5/8	1.29
-U-C6-TF4	3/8	1/4	0.28	3/4	1.48
-U-C6-TF6	3/8	3/8	0.28	7/8	1.54
-U-C6-TF8	3/8	1/2	0.28	1 1/16	1.73
-U-C8-TF4	1/2	1/4	0.41	13/16	1.59
-U-C8-TF6	1/2	3/8	0.41	7/8	1.65
-U-C8-TF8	1/2	1/2	0.41	1 1/16	1.84
-U-C8-TF12	1/2	3/4	0.41	1 5/16	1.90
-U-C10-TF6	5/8	3/8	0.50	15/16	1.65
-U-C10-TF8	5/8	1/2	0.50	1 1/16	1.84
-U-C12-TF8	3/4	1/2	0.62	1 1/16	1.84
-U-C12-TF12	3/4	3/4	0.62	1 5/16	1.90
-U-C14-TF12	7/8	3/4	0.72	1 5/16	1.96
-U-C16-TF12	1	3/4	0.88	1 3/8	2.10
-U-C16-TF16	1	1	0.88	1 5/8	2.45

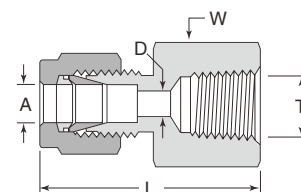

NPT内螺纹直通终端接头(公制)

基本订购号	导管外径A (mm)	内螺纹T (NPT)	孔径D (mm)	六角W (mm)	长度L (mm)
-U-C3M-TF2	3	1/8	2.4	14	28.7
-U-C3M-TF4	3	1/4	2.4	19	33.5
-U-C4M-TF2	4	1/8	2.4	14	29.7
-U-C6M-TF2	6	1/8	4.8	14	31.3
-U-C6M-TF4	6	1/4	4.8	19	35.8
-U-C6M-TF6	6	3/8	4.8	22	37.6
-U-C6M-TF8	6	1/2	4.8	27	42.5
-U-C8M-TF2	8	1/8	6.4	15	32.1
-U-C8M-TF4	8	1/4	6.4	19	37.0
-U-C8M-TF6	8	3/8	6.4	22	38.5
-U-C8M-TF8	8	1/2	6.4	27	43.3
-U-C10M-TF4	10	1/4	7.9	19	37.8
-U-C10M-TF6	10	3/8	7.9	22	39.4
-U-C10M-TF8	10	1/2	7.9	27	44.2
-U-C12M-TF4	12	1/4	9.5	22	40.3
-U-C12M-TF6	12	3/8	9.5	22	41.9
-U-C12M-TF8	12	1/2	9.5	27	46.7
-U-C15M-TF8	15	1/2	11.9	27	46.7
-U-C16M-TF8	16	1/2	12.7	27	46.9
-U-C20M-TF8	20	1/2	15.9	30	47.9
-U-C20M-TF12	20	3/4	15.9	35	49.7
-U-C22M-TF12	22	3/4	18.3	35	49.7
-U-C25M-TF12	25	3/4	21.8	35	53.4
-U-C25M-TF16	25	1	21.8	41	62.3

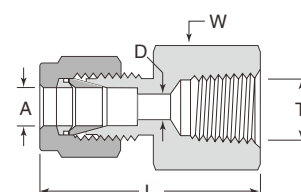

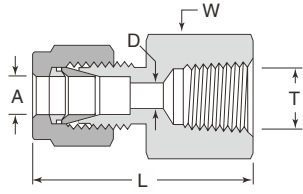

ISO/BSP锥形内螺纹直通终端接头

基本订购号	导管外径A (mm)	内螺纹T (R/BSPT)	孔径D (mm)	六角W (mm)	长度L (mm)
-U-C3M-RC2	3	1/8	2.4	14	28.7
-U-C6M-RC2	6	1/8	4.8	14	31.3
-U-C6M-RC4	6	1/4	4.8	19	35.8
-U-C6M-RC6	6	3/8	4.8	22	37.6
-U-C6M-RC8	6	1/2	4.8	27	42.5
-U-C8M-RC2	8	1/8	6.4	15	32.1
-U-C8M-RC4	8	1/4	6.4	19	37.0
-U-C8M-RC6	8	3/8	6.4	22	38.5
-U-C8M-RC8	8	1/2	6.4	27	43.3
-U-C10M-RC2	10	1/8	7.9	18	33.0
-U-C10M-RC4	10	1/4	7.9	19	37.8
-U-C10M-RC6	10	3/8	7.9	22	39.4
-U-C10M-RC8	10	1/2	7.9	27	44.2
-U-C12M-RC2	12	1/8	8.3	22	35.5
-U-C12M-RC4	12	1/4	9.5	22	40.3
-U-C12M-RC6	12	3/8	9.5	22	41.9
-U-C12M-RC8	12	1/2	9.5	27	46.7
-U-C12M-RC12	12	3/4	9.5	35	49.0
-U-C15M-RC6	15	3/8	11.9	24	41.9
-U-C15M-RC8	15	1/2	11.9	27	46.7
-U-C20M-RC8	20	1/2	15.9	30	47.9
-U-C20M-RC12	20	3/4	15.9	35	49.7
-U-C22M-RC12	22	3/4	18.3	35	49.7
-U-C25M-RC12	25	3/4	21.8	35	53.4
-U-C25M-RC16	25	1	21.8	41	62.3

ISO/BSP平行内螺纹直通终端接头

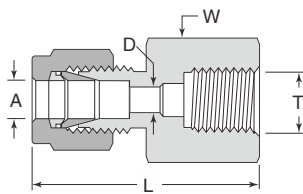

基本订购号	导管外径A (mm)	内螺纹T (R/BSPT)	孔径D (mm)	六角W (mm)	长度L (mm)
-U-C3M-GF4	3	1/4	2.4	19	35.3
-U-C6M-GF4	6	1/4	4.8	19	37.6
-U-C6M-GF6	6	3/8	4.8	24	37.6
-U-C6M-GF8	6	1/2	4.8	27	43.5
-U-C8M-GF4	8	1/4	5.5	19	38.5
-U-C8M-GF6	8	3/8	6.5	24	36.2
-U-C8M-GF8	8	1/2	7.0	27	41.0
-U-C10M-GF4	10	1/4	5.5	19	39.4
-U-C10M-GF6	10	3/8	6.5	24	38.8
-U-C10M-GF8	10	1/2	7.0	27	42.1
-U-C12M-GF4	12	1/4	5.5	22	41.9
-U-C12M-GF6	12	3/8	6.5	24	44.4
-U-C12M-GF8	12	1/2	7.0	27	48.2
-U-C20M-GF8	20	1/2	7.0	30	54.3
-U-C22M-GF8	22	1/2	7.0	30	54.3

卡套管承插焊卡套直通接头

基本订购号	导管外径A (in)	承插焊管径P (in)	承插焊深度H (in)	孔径D (in)	六角W (in)	长度L (in)
-U-C2-CWT2	1/8	1/8	0.50	0.09	7/16	1.14
-U-C4-CWT4	1/4	1/4	0.60	0.19	1/2	1.32
-U-C6-CWT6	3/8	3/8	0.66	0.28	5/8	1.48
-U-C8-CWT8	1/2	1/2	0.90	0.41	13/16	1.62
-U-C12-CWT12	3/4	3/4	0.96	0.62	1 1/16	1.71
-U-C16-CWT16	1	1	1.23	0.88	1 3/8	2.07

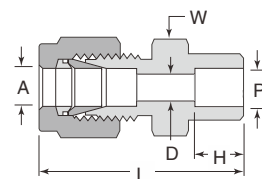

公称管对焊卡套直通接头(英制)

基本订购号	导管外径A (in)	公称管规格 (in)	焊接尺寸J (in)	孔径D (in)	六角W (in)	长度L (in)
-U-C2-DWP2	1/8	1/8	0.405	0.09	7/16	1.20
-U-C3-DWP2	3/16	1/8	0.405	0.12	7/16	1.23
-U-C4-DWP2	1/4	1/8	0.405	0.19	1/2	1.29
-U-C4-DWP4	1/4	1/4	0.540	0.19	9/16	1.49
-U-C5-DWP2	5/16	1/8	0.405	0.21	9/16	1.34
-U-C5-DWP4	5/16	1/4	0.540	0.25	9/16	1.52
-U-C6-DWP4	3/8	1/4	0.540	0.28	5/8	1.57
-U-C6-DWP6	3/8	3/8	0.675	0.28	11/16	1.57
-U-C6-DWP8	3/8	1/2	0.840	0.28	7/8	1.82
-U-C6-DWP12	3/8	3/4	1.050	0.28	1 1/6	1.88
-U-C8-DWP6	1/2	3/8	0.675	0.41	13/16	1.71
-U-C8-DWP8	1/2	1/2	0.840	0.41	7/8	1.93
-U-C8-DWP12	1/2	3/4	1.050	0.41	1 1/16	1.99
-U-C8-DWP16	1/2	1	1.315	0.41	1 3/8	2.25
-U-C10-DWP8	5/8	1/2	0.840	0.50	15/16	1.93
-U-C12-DWP8	3/4	1/2	0.840	0.55	1 1/16	1.99
-U-C12-DWP12	3/4	3/4	1.050	0.62	1 1/16	1.99
-U-C16-DWP16	1	1	1.315	0.88	1 3/8	2.45

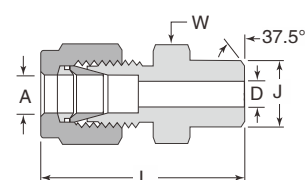

公称管对焊卡套直通接头(公制)

基本订购号	导管外径A (in)	公称管规格 (in)	焊接尺寸J (in)	孔径D (in)	六角W (in)	长度L (in)
-U-C3M-DWP2	3	1/8	10.3	2.4	12	30.5
-U-C4M-DWP2	4	1/8	10.3	2.4	12	31.2
-U-C6M-DWP2	6	1/8	10.3	4.8	14	32.8
-U-C6M-DWP4	6	1/4	13.7	4.8	14	37.9
-U-C8M-DWP2	8	1/8	10.3	5.4	15	34.2
-U-C8M-DWP4	8	1/4	13.7	6.4	15	38.7
-U-C8M-DWP8	8	1/2	21.3	6.4	22	45.6
-U-C10M-DWP4	10	1/4	13.7	7.5	18	40.9
-U-C10M-DWP6	10	3/8	17.1	7.9	18	40.9
-U-C10M-DWP8	10	1/2	21.3	7.9	22	46.5
-U-C12M-DWP4	12	1/4	13.7	7.5	22	43.4
-U-C12M-DWP6	12	3/8	17.1	9.5	22	43.4
-U-C12M-DWP8	12	1/2	21.3	9.5	22	49.0
-U-C14M-DWP6	14	3/8	17.1	10.7	24	44.1
-U-C15M-DWP8	15	1/2	21.3	11.9	24	49.0
-U-C16M-DWP8	16	1/2	21.3	12.7	24	49.0
-U-C18M-DWP8	18	1/2	21.3	13.9	27	50.5

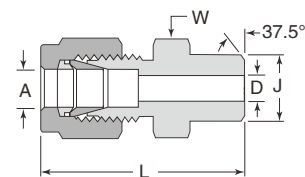

卡套管接头

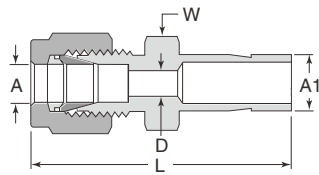

卡套转卡套短管直通接头(英制)

基本订购号	导管外径A (in)	卡套短管A1 (in)	孔径D (in)	六角W (in)	长度L (in)
-U-C1-P2	1/16	1/8	0.05	5/16	1.15
-U-C1-P4	1/16	1/4	0.05	5/16	1.24
-U-C2-P1	1/8	1/16	0.03	7/16	1.14
-U-C2-P2	1/8	1/8	0.08	7/16	1.32
-U-C2-P3	1/8	3/16	0.09	7/16	1.35
-U-C2-P4	1/8	1/4	0.09	7/16	1.42
-U-C2-P6	1/8	3/8	0.09	7/16	1.48
-U-C2-P8	1/8	1/2	0.09	9/16	1.74
-U-C3-P2	3/16	1/8	0.08	7/16	1.37
-U-C3-P4	3/16	1/4	0.12	7/16	1.46
-U-C4-P2	1/4	1/8	0.08	1/2	1.45
-U-C4-P3	1/4	3/16	0.12	1/2	1.48
-U-C4-P4	1/4	1/4	0.17	1/2	1.54
-U-C4-P5	1/4	5/16	0.19	1/2	1.57
-U-C4-P6	1/4	3/8	0.19	1/2	1.60
-U-C4-P8	1/4	1/2	0.19	9/16	1.82
-U-C4-P10	1/4	5/8	0.19	11/16	1.89
-U-C4-P12	1/4	3/4	0.19	13/16	1.88
-U-C5-P6	5/16	3/8	0.25	9/16	1.65
-U-C5-P8	5/16	1/2	0.25	9/16	1.87
-U-C6-P4	3/8	1/4	0.17	5/8	1.63
-U-C6-P6	3/8	3/8	0.27	5/8	1.70
-U-C6-P8	3/8	1/2	0.28	5/8	1.91
-U-C6-P10	3/8	5/8	0.28	11/16	1.98
-U-C6-P12	3/8	3/4	0.28	13/16	1.98
-U-C8-P4	1/2	1/4	0.17	13/16	1.77
-U-C8-P6	1/2	3/8	0.27	13/16	1.84
-U-C8-P8	1/2	1/2	0.37	13/16	2.06
-U-C8-P10	1/2	5/8	0.41	13/16	2.12
-U-C8-P12	1/2	3/4	0.41	13/16	2.12
-U-C8-P16	1/2	1	0.41	1 1/16	2.37
-U-C10-P12	5/8	3/4	0.50	15/16	2.15
-U-C10-P14	5/8	7/8	0.50	15/16	2.21
-U-C10-P16	5/8	1	0.50	1 1/16	2.40
-U-C12-P8	3/4	1/2	0.37	1 1/16	2.15
-U-C12-P16	3/4	1	0.62	1 1/16	2.46
-U-C16-P20	1	1 1/4	0.88	1 3/8	3.17
-U-C16-P24	1	1 1/2	0.88	1 5/8	3.51
-U-C16-P32	1	2	0.88	2 1/8	4.43

卡套转卡套短管直通接头(公制)

基本订购号	导管外径A (mm)	卡套短管A1 (NPT)	孔径D (mm)	六角W (mm)	长度L (mm)
-U-C2M-P3M	2	3	1.7	12	33.5
-U-C3M-P4M	3	4	2.4	12	35.0
-U-C3M-P6M	3	6	2.4	12	36.1
-U-C3M-P10M	3	10	2.4	14	38.4
-U-C4M-P6M	4	6	2.4	12	37.1
-U-C6M-P3M	6	3	1.9	14	36.9
-U-C6M-P8M	6	8	4.8	14	39.9
-U-C6M-P10M	6	10	4.8	14	40.7
-U-C6M-P12M	6	12	4.8	14	46.3
-U-C6M-P18M	6	18	4.8	22	49.6
-U-C8M-P6M	8	6	4.1	15	40.3
-U-C8M-P10M	8	10	6.4	15	42.0
-U-C8M-P12M	8	12	6.4	15	47.6
-U-C10M-P6M	10	6	4.1	18	42.4
-U-C10M-P8M	10	8	5.6	18	43.4
-U-C10M-P12M	10	12	7.9	18	49.8
-U-C10M-P15M	10	15	7.9	18	51.3
-U-C10M-P18M	10	18	7.9	22	51.3
-U-C12M-P6M	12	6	4.1	22	44.9
-U-C12M-P8M	12	8	5.6	22	45.9
-U-C12M-P10M	12	10	7.1	22	46.7
-U-C12M-P16M	12	16	9.5	22	53.8
-U-C12M-P18M	12	18	9.5	22	53.8
-U-C12M-P20M	12	20	9.5	22	56.1
-U-C12M-P22M	12	22	9.5	24	56.1
-U-C12M-P25M	12	25	9.5	27	62.4
-U-C16M-P12M	16	12	8.8	24	53.0
-U-C18M-P12M	18	12	8.8	27	54.6
-U-C18M-P16M	18	16	12.0	27	56.1
-U-C18M-P20M	18	20	15.1	27	57.6
-U-C18M-P22M	18	22	15.1	27	57.6
-U-C18M-P25M	18	25	15.1	27	62.4
-U-C20M-P16M	20	16	12.0	30	57.9
-U-C20M-P18M	20	18	13.9	30	57.9
-U-C20M-P22M	20	22	15.9	30	59.4
-U-C20M-P25M	20	25	15.9	30	64.2
-U-C22M-P18M	22	18	13.9	30	57.9
-U-C22M-P20M	22	20	15.5	30	59.4
-U-C22M-P25M	22	25	18.3	30	64.2
-U-C25M-P18M	25	18	13.9	35	63.1
-U-C25M-P20M	25	20	15.5	35	64.6

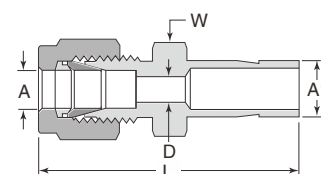

卡套管接头

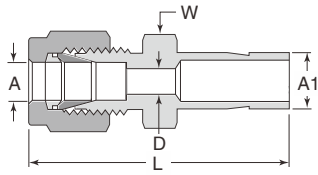

卡套转卡套短管直通接头(公制转英制)

基本订购号	导管外径A (mm)	卡套短管A1 (NPT)	孔径D (mm)	六角W (mm)	长度L (mm)
-U-C2M-P2	2	1/8	1.7	12	33.5
-U-C3M-P2	3	1/8	2.0	12	33.5
-U-C3M-P4	3	1/4	2.4	12	36.1
-U-C4M-P4	4	1/4	2.4	12	37.1
-U-C6M-P2	6	1/8	2.0	14	36.9
-U-C6M-P4	6	1/4	4.4	14	39.2
-U-C6M-P5	6	5/16	4.8	14	39.9
-U-C6M-P6	6	3/8	4.8	14	40.7
-U-C6M-P8	6	1/2	4.8	14	46.3
-U-C8M-P4	8	1/4	4.4	15	40.3
-U-C8M-P6	8	3/8	6.4	15	42.0
-U-C8M-P8	8	1/2	6.4	15	47.6
-U-C10M-P6	10	3/8	6.8	18	44.2
-U-C10M-P8	10	1/2	7.9	18	49.8
-U-C12M-P8	12	1/2	9.3	27	52.3
-U-C12M-P12	12	3/4	9.5	27	53.8
-U-C18M-P12	18	3/4	14.7	22	56.1
-U-C18M-P16	18	1	15.1	22	62.4
-U-C25M-P16	25	1	20.2	35	69.5

37°扩口卡套直通接头

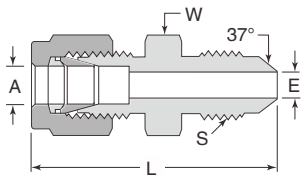

基本订购号	导管外径A (in)	AN扩口管 (in)	扩口螺纹S (UN)	孔径D (in)	六角W (in)	长度L (in)
-U-C1-AN2	1/16	1/8	5/16-24UNJF-3	0.05	7/16	1.07
-U-C2-AN2	1/8	1/8	5/16-24UNJF-3	0.06	7/16	1.27
-U-C2-AN4	1/8	1/4	7/16-20UNJF-3	0.09	1/2	1.38
-U-C4-AN4	1/4	1/4	7/16-20UNJF-3	0.17	1/2	1.48
-U-C5-AN5	5/16	5/16	1/2-20UNJF-3	0.23	9/16	1.51
-U-C6-AN4	3/8	1/4	7/16-20UNJF-3	0.17	5/8	1.56
-U-C6-AN6	3/8	3/8	9/16-18UNJF-3	0.28	5/8	1.56
-U-C8-AN8	1/2	1/2	3/4-16UNJF-3	0.39	13/16	1.81
-U-C12-AN12	3/4	3/4	1 1/16-12UNJ-3	0.61	1 1/8	2.10
-U-C16-AN16	1	1	1 5/16-12UNJ-3	0.84	1 3/8	2.42

卡套直通穿板接头(公制)

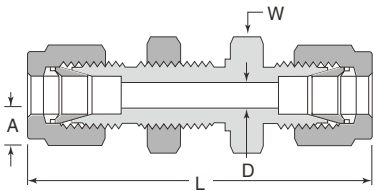

基本订购号	导管外径A (mm)	孔径D (mm)	六角W (mm)	长度L (mm)	面板孔径 (mm)	最大面板厚度 (mm)
-BU-C3M	3	2.4	14	51.3	8.3	12.7
-BU-C4M	4	2.4	14	53.6	9.9	12.7
-BU-C6M	6	4.8	16	57.7	11.5	10.2
-BU-C8M	8	6.4	18	61.0	13.1	11.2
-BU-C10M	10	7.9	22	63.7	16.3	11.2
-BU-C12M	12	9.5	24	71.0	19.5	12.7
-BU-C14M	14	11.1	27	72.5	22.5	12.7
-BU-C15M	15	11.9	27	72.5	22.8	12.7
-BU-C16M	16	12.7	27	72.5	22.8	12.7
-BU-C18M	18	15.1	30	78.9	26.0	16.8
-BU-C20M	20	15.9	35	84.5	29.0	19.0
-BU-C25M	25	21.8	41	96.0	34.0	19.0

卡套直通穿板接头(英制)

基本订购号	导管外径A (in)	孔径D (in)	六角W (in)	长度L (in)	面板孔径 (in)	最大面板厚度 (in)
-BU-C1	1/16	0.05	5/16	1.24	13/64	0.12
-BU-C2	1/8	0.09	1/2	2.02	21/64	0.50
-BU-C3	3/16	0.12	9/16	2.11	25/64	0.50
-BU-C4	1/4	0.19	5/8	2.27	29/64	0.40
-BU-C5	5/16	0.25	11/16	2.39	33/64	0.44
-BU-C6	3/8	0.28	3/4	2.45	37/64	0.44
-BU-C8	1/2	0.41	15/16	2.80	49/64	0.50
-BU-C10	5/8	0.50	1 1/16	2.86	57/64	0.50
-BU-C12	3/4	0.62	1 3/16	3.11	1 1/64	0.66
-BU-C16	1	0.88	1 5/8	3.77	1 21/64	0.75

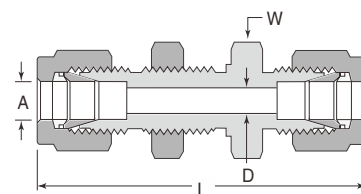

NPT外螺纹卡套直通穿板接头(英制)

基本订购号	导管外径A (in)	外螺纹T (NPT)	孔径D (in)	六角W (in)	长度L (in)	面板孔径 (in)	最大面板厚度 (in)
-BU-C2-T2	1/8	1/8	0.09	1/2	1.83	21/64	0.50
-BU-C4-T2	1/4	1/8	0.19	5/8	1.95	29/64	0.40
-BU-C4-T4	1/4	1/4	0.19	5/8	2.13	29/64	0.40
-BU-C6-T4	3/8	1/4	0.28	3/4	2.26	37/64	0.44
-BU-C6-T6	3/8	3/8	0.28	3/4	2.26	37/64	0.44
-BU-C6-T8	3/8	1/2	0.28	7/8	2.51	37/64	0.44
-BU-C8-T6	1/2	3/8	0.38	15/16	2.49	49/64	0.50
-BU-C8-T8	1/2	1/2	0.41	15/16	2.71	49/64	0.50
-BU-C12-T12	3/4	3/4	0.62	1 3/16	3.00	1 1/64	0.66
-BU-C16-T16	1	1	0.88	1 5/8	3.67	1 21/64	0.75

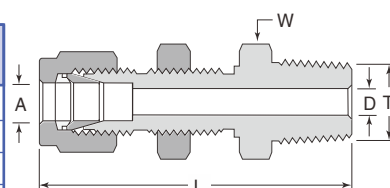

NPT外螺纹卡套直通穿板接头(公制)

基本订购号	导管外径A (in)	外螺纹T (NPT)	孔径D (mm)	六角W (mm)	长度L (mm)	面板孔径 (mm)	最大面板厚度 (mm)
-BU-C6M-T2	6	1/8	4.8	16	49.5	11.5	10.2
-BU-C6M-T4	6	1/4	4.8	16	53.6	11.5	10.2
-BU-C12M-T8	12	1/2	9.5	24	68.8	19.5	12.7

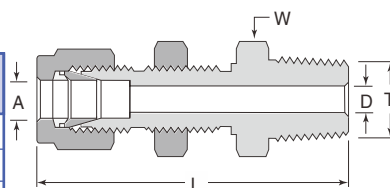

NPT内螺纹卡套直通穿板接头(英制)

基本订购号	导管外径A (in)	内螺纹T (NPT)	孔径D (in)	六角W (in)	长度L (in)	面板孔径 (in)	最大面板厚度 (in)
-BU-C2-TF2	1/8	1/8	0.09	9/16	1.76	21/64	0.50
-BU-C4-TF2	1/4	1/8	0.19	5/8	1.85	29/64	0.40
-BU-C4-TF4	1/4	1/4	0.19	3/4	2.04	29/64	0.40
-BU-C6-TF4	3/8	1/4	0.28	3/4	2.17	37/64	0.44
-BU-C8-TF6	1/2	3/8	0.41	15/16	2.43	49/64	0.50
-BU-C8-TF8	1/2	1/2	0.41	1 1/16	2.62	49/64	0.50

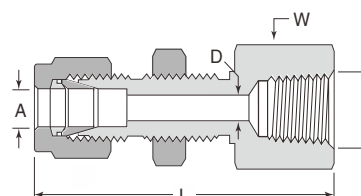

卡套管接头

卡套转卡套短管穿板接头

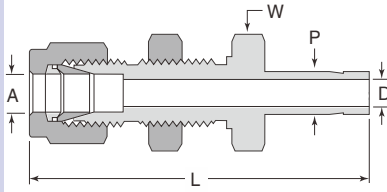

基本订购号	导管外径A (in)	卡套短管P (in)	孔径D (in)	六角W (in)	长度L (in)	面板孔径 (in)	最大面板厚度 (in)
-BU-C2-P2	1/8	1/8	0.08	1/2	1.95	21/64	0.50
-BU-C4-P4	1/4	1/4	0.17	5/8	2.20	29/64	0.40
-BU-C6-P6	3/8	3/8	0.27	3/4	2.41	37/64	0.44
-BU-C8-P8	1/2	1/2	0.37	15/16	2.87	49/64	0.50
-BU-C10-P10	5/8	5/8	0.47	1 1/16	2.96	57/64	0.50
-BU-C12-P12	3/4	3/4	0.58	1 3/16	3.21	1 1/64	0.66
-BU-C16-P16	1	1	0.80	1 5/8	3.95	1 21/64	0.75

37°扩口卡套直通穿板接头

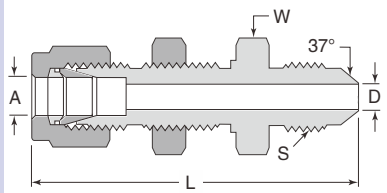

基本订购号	导管外径A (in)	AN扩口管 (in)	扩口螺纹S (UN)	孔径D (in)	六角W (in)	长度L (in)	面板孔尺寸	最大面板厚度
-BU-C4-AN4	1/4	1/4	7/16-20UNJF-3	0.17	5/8	2.12	29/64	0.40
-BU-C6-AN6	3/8	3/8	9/16-18UNJF-3	0.28	3/4	2.25	37/64	0.44
-BU-C8-AN8	1/2	1/2	3/4-16UNJF-3	0.39	15/16	2.59	49/64	0.50
-BU-C12-AN12	3/4	3/4	1 1/16-12UNJ-3	0.61	1 3/16	3.11	1 1/64	0.66
-BU-C16-AN16	1	1	1 5/16-12UNJ-3	0.84	1 5/8	3.64	1 21/64	0.75

卡套短管外螺纹直通接头(英制)

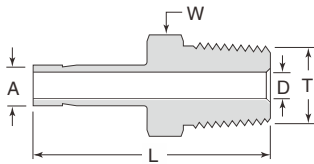

基本订购号	卡套短管A (in)	外螺纹T (NPT)	孔径D (in)	六角W (in)	长度L (in)
-U-P2-T2	1/8	1/8	0.08	7/16	1.16
-U-P2-T4	1/8	1/4	0.08	9/16	1.37
-U-P3-T2	3/16	1/8	0.12	7/16	1.19
-U-P3-T4	3/16	1/4	0.12	9/16	1.40
-U-P4-T2	1/4	1/8	0.17	7/16	1.25
-U-P4-T4	1/4	1/4	0.17	9/16	1.46
-U-P4-T6	1/4	3/8	0.17	11/16	1.49
-U-P4-T8	1/4	1/2	0.17	7/8	1.71
-U-P5-T2	5/16	1/8	0.19	7/16	1.29
-U-P5-T4	5/16	1/4	0.22	9/16	1.50
-U-P6-T2	3/8	1/8	0.19	7/16	1.32
-U-P6-T4	3/8	1/4	0.27	9/16	1.53
-U-P6-T6	3/8	3/8	0.27	11/16	1.56
-U-P6-T8	3/8	1/2	0.27	7/8	1.78
-U-P8-T4	1/2	1/4	0.28	9/16	1.75
-U-P8-T6	1/2	3/8	0.37	11/16	1.78
-U-P8-T8	1/2	1/2	0.37	7/8	2.00
-U-P10-T8	5/8	1/2	0.47	7/8	2.06
-U-P12-T8	3/4	1/2	0.47	7/8	2.06
-U-P12-T8	3/4	3/4	0.58	1 1/16	2.06
-U-P16-T12	1	3/4	0.62	1 1/16	2.31
-U-P16-T16	1	1	0.80	1 3/8	2.60

卡套管外螺纹直通接头(公制)

基本订购号	卡套管A (mm)	外螺纹T (NPT)	孔径D (mm)	六角W (mm)	长度L (mm)
-U-P6M-T2	6	1/8	4.1	12	32.8
-U-P6M-T4	6	1/4	4.1	14	38.1
-U-P8M-T4	8	1/4	5.6	14	39.1
-U-P8M-T6	8	3/8	5.6	19	39.9
-U-P10M-T4	10	1/4	7.1	14	39.9
-U-P10M-T6	10	3/8	7.1	18	40.6
-U-P10M-T8	10	1/2	7.1	22	46.2
-U-P12M-T4	12	1/4	7.1	16	46.5
-U-P12M-T8	12	1/2	8.8	22	52.1

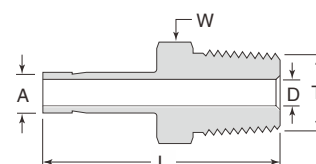

卡套管内螺纹直通接头(英制)

基本订购号	卡套管A (in)	内螺纹T (NPT)	孔径D (in)	六角W (in)	长度L (in)
-U-P2-TF2	1/8	1/8	0.08	9/16	1.24
-U-P2-TF4	1/8	1/4	0.08	3/4	1.39
-U-P3-TF4	3/16	1/4	0.12	3/4	1.41
-U-P4-TF2	1/4	1/8	0.17	9/16	1.30
-U-P4-TF4	1/4	1/4	0.17	3/4	1.46
-U-P4-TF6	1/4	3/8	0.17	7/8	1.55
-U-P4-TF8	1/4	1/2	0.17	1 1/16	1.79
-U-P5-TF4	5/16	1/4	0.22	3/4	1.48
-U-P6-TF2	3/8	1/8	0.27	9/16	1.35
-U-P6-TF4	3/8	1/4	0.27	3/4	1.50
-U-P6-TF6	3/8	3/8	0.27	7/8	1.59
-U-P6-TF8	3/8	1/2	0.27	1 1/16	1.84
-U-P8-TF4	1/2	1/4	0.37	3/4	1.71
-U-P8-TF6	1/2	3/8	0.37	7/8	1.79
-U-P8-TF8	1/2	1/2	0.37	1 1/16	2.05
-U-P10-T8	5/8	1/2	0.47	1 1/16	2.09
-U-P12-TF8	3/4	1/2	0.58	1 1/16	2.08
-U-P12-TF12	3/4	3/4	0.58	1 5/16	2.16
-U-P12-TF16	3/4	1	0.58	1 5/8	2.30
-U-P16-TF12	1	3/4	0.80	1 5/16	2.39
-U-P16-TF16	1	1	0.80	1 5/8	2.53

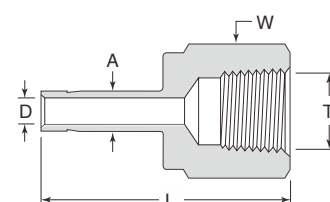

卡套管内螺纹直通接头(公制)

基本订购号	卡套管A (mm)	内螺纹T (NPT)	孔径D (mm)	六角W (mm)	长度L (mm)
-U-P6M-TF2	6	1/8	4.1	14	32.5
-U-P6M-TF4	6	1/4	4.1	19	37.1
-U-P8M-TF4	8	1/4	5.6	19	37.6
-U-P10M-TF4	10	1/4	7.1	19	38.1
-U-P10M-TF6	10	3/8	7.1	22	40.1
-U-P10M-TF8	10	1/2	7.1	27	46.7
-U-P12M-TF4	12	1/4	8.8	19	43.7
-U-P12M-TF8	12	1/2	8.8	27	52.3

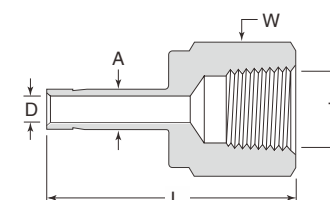

卡套管接头

卡套直角中间接头(英制)

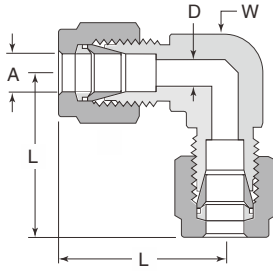

基本订购号	导管外径A (in)	孔径D (in)	六角W (in)	长度L (in)
-L-C2	1/8	0.09	3/8	0.88
-L-C3	3/16	0.12	1/2	1.00
-L-C4	1/4	0.19	1/2	1.06
-L-C5	5/16	0.25	9/16	1.13
-L-C6	3/8	0.28	5/8	1.20
-L-C8	1/2	0.41	13/16	1.42
-L-C10	5/8	0.50	15/16	1.50
-L-C12	3/4	0.62	1 1/16	1.57
-L-C14	7/8	0.72	1 3/8	1.76
-L-C16	1	0.88	1 3/8	1.93

卡套直角中间接头(公制)

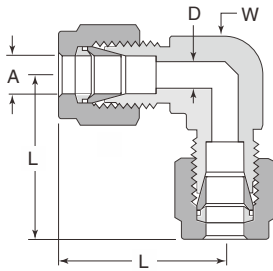

基本订购号	导管外径A (mm)	孔径D (mm)	六角W (in)	长度L (mm)
-L-C3M	3	2.4	3/8	22.3
-L-C4M	4	2.4	1/2	25.4
-L-C6M	6	4.8	1/2	27.0
-L-C8M	8	6.4	9/16	28.8
-L-C10M	10	7.9	11/16	31.5
-L-C12M	12	9.5	13/16	36.0
-L-C14M	14	11.1	15/16	38.0
-L-C15M	15	11.9	15/16	38.0
-L-C16M	16	12.7	15/16	38.0
-L-C18M	18	15.1	1 1/16	39.8
-L-C20M	20	15.9	1 3/8	44.6
-L-C22M	22	18.3	1 3/8	44.6
-L-C25M	25	21.8	1 3/8	49.1

NPT外螺纹卡套直角接头(英制)

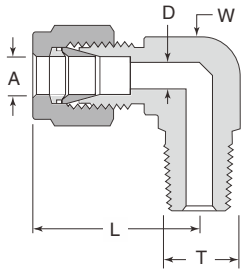

基本订购号	导管外径A (in)	外螺纹T (NPT)	孔径D (in)	六角W (in)	长度L (in)
-L-C1-T1	1/16	1/16	0.05	7/16	0.75
-L-C1-T2	1/16	1/8	0.05	7/16	0.75
-L-C2-T1	1/8	1/16	0.09	7/16	0.93
-L-C2-T2	1/8	1/8	0.09	7/16	0.93
-L-C2-T4	1/8	1/4	0.09	1/2	0.97
-L-C3-T2	3/16	1/8	0.12	1/2	1.00
-L-C3-T4	3/16	1/4	0.12	1/2	1.00
-L-C4-T1	1/4	1/16	0.12	1/2	1.06
-L-C4-T2	1/4	1/8	0.19	1/2	1.06
-L-C4-T4	1/4	1/4	0.19	1/2	1.06
-L-C4-T6	1/4	3/8	0.19	11/16	1.17
-L-C4-T8	1/4	1/2	0.19	13/16	1.25
-L-C5-T2	5/16	1/8	0.19	9/16	1.13
-L-C5-T4	5/16	1/4	0.25	9/16	1.13
-L-C5-T6	5/16	3/8	0.25	11/16	1.20
-L-C6-T2	3/8	1/8	0.19	5/8	1.20
-L-C6-T4	3/8	1/4	0.28	5/8	1.20
-L-C6-T6	3/8	3/8	0.28	11/16	1.23
-L-C6-T8	3/8	1/2	0.28	13/16	1.31
-L-C6-T12	3/8	3/4	0.28	1 1/16	1.46

NPT外螺纹卡套直角接头(英制)

基本订购号	导管外径A (in)	外螺纹T (NPT)	孔径D (in)	六角W (in)	长度L (in)
-L-C6-T12	3/8	3/4	0.28	1 1/16	1.46
-L-C8-T4	1/2	1/4	0.28	13/16	1.42
-L-C8-T6	1/2	3/8	0.38	13/16	1.42
-L-C8-T8	1/2	1/2	0.41	13/16	1.42
-L-C8-T12	1/2	3/4	0.41	1 1/16	1.57
-L-C10-T6	5/8	3/8	0.38	15/16	1.50
-L-C10-T8	5/8	1/2	0.47	15/16	1.50
-L-C10-T12	5/8	3/4	0.50	1 1/16	1.57
-L-C12-T8	3/4	1/2	0.47	1 1/16	1.57
-L-C12-T12	3/4	3/4	0.62	1 1/16	1.57
-L-C14-T12	7/8	3/4	0.62	1 3/8	1.76
-L-C16-T12	1	3/4	0.62	1 3/8	1.93
-L-C16-T16	1	1	0.88	1 3/8	1.93

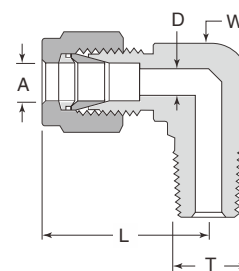

NPT外螺纹卡套直角接头(公制)

基本订购号	导管外径A (mm)	外螺纹T (NPT)	孔径D (mm)	六角W (in)	长度L (mm)
-L-C3M-T2	3	1/8	2.4	7/16	23.6
-L-C3M-T4	3	1/4	2.4	1/2	24.6
-L-C4M-T2	4	1/8	2.4	1/2	25.4
-L-C4M-T4	4	1/4	2.4	1/2	25.4
-L-C6M-T2	6	1/8	4.8	1/2	27.0
-L-C6M-T4	6	1/4	4.8	1/2	27.0
-L-C6M-T6	6	3/8	4.8	11/16	29.8
-L-C6M-T8	6	1/2	4.8	13/16	31.8
-L-C8M-T2	8	1/8	4.8	9/16	28.8
-L-C8M-T4	8	1/4	6.4	9/16	28.8
-L-C8M-T6	8	3/8	6.4	11/16	30.6
-L-C8M-T8	8	1/2	6.4	13/16	32.6
-L-C10M-T2	10	1/8	4.8	11/16	31.5
-L-C10M-T4	10	1/4	7.1	11/16	31.5
-L-C10M-T6	10	3/8	7.9	11/16	31.5
-L-C10M-T8	10	1/2	7.9	13/16	33.5
-L-C12M-T4	12	1/4	7.1	13/16	36.0
-L-C12M-T6	12	3/8	9.5	13/16	36.0
-L-C12M-T8	12	1/2	9.5	13/16	36.0
-L-C12M-T12	12	3/4	9.5	1 1/16	39.8
-L-C15M-T8	15	1/2	11.9	15/16	38.0
-L-C16M-T6	16	3/8	9.5	15/16	38.0
-L-C16M-T8	16	1/2	11.9	15/16	38.0
-L-C16M-T12	16	3/4	12.7	1 1/16	39.8
-L-C18M-T8	18	1/2	11.9	1 1/16	39.8
-L-C18M-T12	18	3/4	15.1	1 1/16	39.8
-L-C20M-T8	20	1/2	11.9	1 3/8	44.6
-L-C20M-T12	20	3/4	15.9	1 3/8	44.6
-L-C22M-T12	22	3/4	15.9	1 3/8	44.6
-L-C22M-T16	22	1	18.3	1 3/8	44.6
-L-C25M-T12	25	3/4	15.9	1 3/8	49.1
-L-C25M-T16	25	1	21.8	1 3/8	49.1

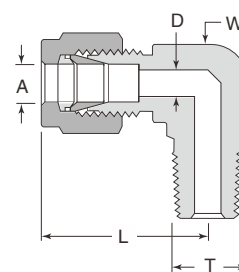

卡套管接头

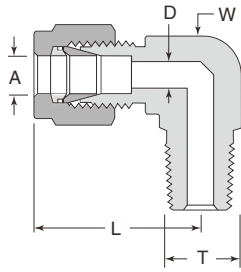

ISO/BSP锥形外螺纹卡套直角接头

基本订购号	导管外径A (mm)	外螺纹T (R/BSPT)	孔径D (mm)	六角W (in)	长度L (mm)
-L-C3M-R2	3	1/8	2.4	7/16	23.6
-L-C3M-R4	3	1/4	2.4	1/2	24.6
-L-C4M-R2	4	1/8	2.4	1/2	25.4
-L-C4M-R4	4	1/4	2.4	1/2	25.4
-L-C6M-R2	6	1/8	4.8	1/2	27.0
-L-C6M-R4	6	1/4	4.8	1/2	27.0
-L-C6M-R6	6	3/8	4.8	11/16	29.8
-L-C6M-R8	6	1/2	4.8	13/16	31.8
-L-C8M-R2	8	1/8	4.8	9/16	28.8
-L-C8M-R4	8	1/4	6.4	9/16	28.8
-L-C8M-R6	8	3/8	6.4	11/16	30.6
-L-C8M-R8	8	1/2	6.4	13/16	32.6
-L-C10M-R4	10	1/4	7.1	11/16	31.5
-L-C10M-R6	10	3/8	7.9	11/16	31.5
-L-C10M-R8	10	1/2	7.9	13/16	33.5
-L-C12M-R2	12	1/8	4.8	13/16	36.0
-L-C12M-R4	12	1/4	7.1	13/16	36.0
-L-C12M-R6	12	3/8	9.5	13/16	36.0
-L-C12M-R8	12	1/2	9.5	13/16	36.0
-L-C12M-R12	12	3/4	9.5	1 1/16	39.8
-L-C14M-R8	14	1/2	11.1	15/16	38.1
-L-C15M-R8	15	1/2	11.9	15/16	38.1
-L-C16M-R6	16	3/8	9.5	15/16	38.0
-L-C16M-R8	16	1/2	11.9	15/16	38.0
-L-C18M-R8	18	1/2	11.9	1 1/16	39.8
-L-C18M-R12	18	3/4	15.1	1 1/16	39.8
-L-C20M-R8	20	1/2	11.9	1 3/8	44.6
-L-C20M-R12	20	3/4	15.9	1 3/8	44.6
-L-C22M-R12	22	3/4	15.9	1 3/8	44.6
-L-C22M-R16	22	1	18.3	1 3/8	44.6
-L-C25M-R12	25	3/4	15.9	1 3/8	49.1
-L-C25M-R16	25	1	21.8	1 3/8	49.1

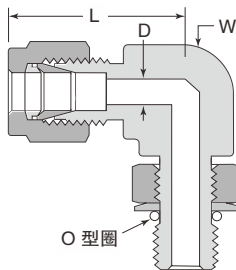

SAE/MS平行外螺纹可定位卡套直角接头

基本订购号	导管外径A (in)	外螺纹T (UN/SAE)	孔径D (in)	六角W (in)	长度L (in)
-L-C4-S4	1/4	7/16-20	0.19	1/2	1.12
-L-C4-S6	1/4	9/16-18	0.19	5/8	1.20
-L-C5-S5	5/16	1/2-20	0.23	9/16	1.19
-L-C6-S4	3/8	7/16-20	0.20	5/8	1.31
-L-C6-S6	3/8	9/16-18	0.28	5/8	1.26
-L-C4-S8	3/8	3/4-16	0.28	13/16	1.37
-L-C8-S6	1/2	9/16-18	0.28	13/16	1.48
-L-C8-S8	1/2	3/4-16	0.41	13/16	1.48
-L-C10-S10	5/8	7/8-14	0.50	15/16	1.56
-L-C12-S12	3/4	1 1/16-12	0.62	1 1/16	1.63
-L-C14-S14	7/8	1 3/16-12	0.72	1 3/16	1.70
-L-C16-S16	1	1 5/16-12	0.88	1 3/8	1.99

NPT内螺纹卡套直角接头(英制)

基本订购号	导管外径A (in)	内螺纹T (NPT)	孔径D (in)	六角W (in)	长度L (in)
-L-C2-TF2	1/8	1/8	0.09	1/2	0.97
-L-C2-TF4	1/8	1/4	0.09	11/16	1.08
-L-C3-TF2	3/16	1/8	0.12	1/2	1.00
-L-C4-TF2	1/4	1/8	0.19	1/2	1.06
-L-C4-TF4	1/4	1/4	0.19	11/16	1.17
-L-C4-TF6	1/4	3/8	0.19	13/16	1.25
-L-C4-TF8	1/4	1/2	0.19	1	1.36
-L-C5-TF2	5/16	1/8	0.25	9/16	1.13
-L-C5-TF4	5/16	1/4	0.25	11/16	1.20
-L-C6-TF2	3/8	1/8	0.28	5/8	1.20
-L-C6-TF4	3/8	1/4	0.28	11/16	1.23
-L-C6-TF6	3/8	3/8	0.28	13/16	1.31
-L-C6-TF8	3/8	1/2	0.28	1	1.42
-L-C8-TF4	1/2	1/4	0.41	13/16	1.42
-L-C8-TF6	1/2	3/8	0.41	13/16	1.42
-L-C8-TF8	1/2	1/2	0.41	1	1.53
-L-C10-TF6	5/8	3/8	0.50	15/16	1.50
-L-C10-TF8	5/8	1/2	0.50	1 1/16	1.57
-L-C12-TF8	3/4	1/2	0.62	1 1/16	1.57
-L-C12-TF12	3/4	3/4	0.62	1 3/8	1.76
-L-C14-TF12	7/8	3/4	0.72	1 3/8	1.76
-L-C16-TF12	1	3/4	0.88	1 3/8	1.93
-L-C16-TF16	1	1	0.88	1 11/16	2.11

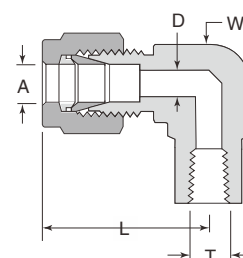

NPT内螺纹卡套直角接头(公制)

基本订购号	导管外径A (mm)	内螺纹T (NPT)	孔径D (mm)	六角W (in)	长度L (mm)
-L-C6M-TF2	6	1/8	4.8	1/2	27.0
-L-C6M-TF4	6	1/4	4.8	11/16	29.8
-L-C6M-TF8	6	1/2	4.8	1	34.6
-L-C8M-TF4	8	1/4	6.4	11/16	30.6
-L-C10M-TF2	10	1/8	7.9	11/16	31.5
-L-C10M-TF4	10	1/4	7.9	13/16	33.5
-L-C12M-TF4	12	1/4	9.5	13/16	36.0
-L-C12M-TF8	12	1/2	9.5	1	38.8
-L-C16M-TF8	16	1/2	12.7	1 1/16	39.5

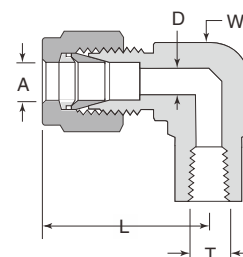

卡套管承插焊卡套直角接头

基本订购号	导管外径A (in)	承插焊F (in)	孔径D (in)	六角W (in)	长度L (in)
-L-C4-CWT4	1/4	1/4	0.19	1/2	1.06
-L-C6-CWT6	3/8	3/8	0.28	5/8	1.20
-L-C8-CWT8	1/2	1/2	0.41	13/16	1.42
-L-C12-CWT12	3/4	3/4	0.62	1 1/16	1.57
-L-C16-CWT16	1	1	0.88	1 3/8	1.93

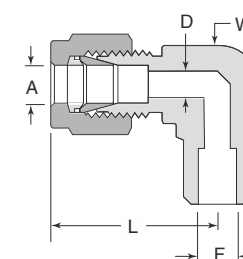

卡套管接头

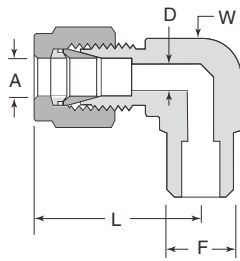

公称管对焊卡套直角接头

基本订购号	导管外径A (in)	公称管规格 (in)	焊接尺寸F (in)	孔径D (in)	六角W (in)	长度L (in)
-L-C4-DWP2	1/4	1/8	0.405	0.19	1/2	1.06
-L-C4-DWP4	1/4	1/4	0.540	0.19	1/2	1.06
-L-C6-DWP4	3/8	1/4	0.540	0.28	5/8	1.20
-L-C8-DWP8	1/2	1/2	0.840	0.41	13/16	1.42
-L-C12-DWP12	3/4	3/4	1.050	0.62	1 1/16	1.57

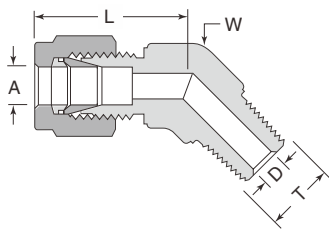

NPT外螺纹卡套45°弯头

基本订购号	导管外径A (in)	外螺纹T (NPT)	孔径D (in)	六角W (in)	长度L (in)
-V-C4-T2	1/4	1/8	0.19	1/2	0.97
-V-C4-T4	1/4	1/4	0.19	1/2	0.97
-V-C6-T2	3/8	1/8	0.19	5/8	1.10
-V-C6-T4	3/8	1/4	0.28	5/8	1.10
-V-C6-T6	3/8	3/8	0.28	13/16	1.15
-V-C8-T6	1/2	3/8	0.38	13/16	1.26
-V-C8-T8	1/2	1/2	0.41	13/16	1.26
-V-C12-T12	3/4	3/4	0.62	1 1/16	1.33
-V-C16-T16	1	1	0.88	1 3/8	1.59

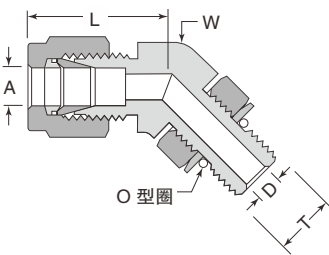

SAE/MS平行外螺纹可定位卡套45°弯头

基本订购号	导管外径A (in)	外螺纹T (UN/SAE)	孔径D (in)	六角W (in)	长度L (in)
-V-C4-S4	1/4	7/16-20	0.19	1/2	1.01
-V-C6-S6	3/8	9/16-18	0.28	5/8	1.10
-V-C8-S8	1/2	3/4-16	0.41	13/16	1.26
-V-C12-S12	3/4	1 1/16-12	0.62	1 1/16	1.33
-V-C16-S16	1	1 5/16-12	0.88	1 3/8	1.59

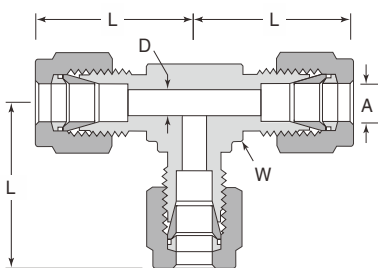

卡套三通中间接头(英制)

基本订购号	导管外径A (in)	孔径D (in)	六角W (in)	长度L (in)
-T-C1	1/16	0.05	3/8	0.70
-T-C2	1/8	0.09	3/8	0.88
-T-C3	3/16	0.12	7/16	0.96
-T-C4	1/4	0.19	1/2	1.06
-T-C5	5/16	0.25	5/8	1.17
-T-C6	3/8	0.28	5/8	1.20
-T-C8	1/2	0.41	13/16	1.42
-T-C10	5/8	0.50	1	1.53
-T-C12	3/4	0.62	1 1/16	1.57
-T-C14	7/8	0.72	1 3/8	1.76
-T-C16	1	0.88	1 3/8	1.93

卡套三通中间接头(公制)

基本订购号	导管外径A (mm)	孔径D (mm)	六角W (in)	长度L (mm)
-T-C2M	2	1.7	3/8	22.3
-T-C3M	3	2.4	3/8	22.3
-T-C4M	4	2.4	1/2	25.4
-T-C6M	6	4.8	1/2	27.0
-T-C8M	8	6.4	5/8	29.9
-T-C10M	10	7.9	11/16	31.5
-T-C12M	12	9.5	13/16	36.0
-T-C14M	14	11.1	1	38.8
-T-C15M	15	11.9	1	38.8
-T-C16M	16	12.7	1	38.8
-T-C18M	18	15.1	1 1/16	39.8
-T-C20M	20	15.9	1 3/8	44.6
-T-C22M	22	18.3	1 3/8	44.6
-T-C25M	25	21.8	1 3/8	49.1

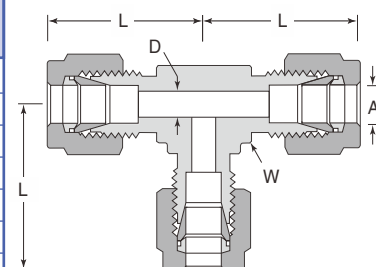

卡套三通异径接头

基本订购号	导管外径A (in)	导管外径A1 (in)	导管外径A2 (in)	孔径D (in)	六角W (in)	长度L (in)	长度L1 (in)	长度L1 (in)
-T-C6-C4-C6	3/8	1/4	3/8	0.19	5/8	1.20	1.14	1.20
-T-C8-C4-C6	1/2	1/4	1/2	0.19	13/16	1.42	1.25	1.42
-T-C8-C6-C8	1/2	3/8	1/2	0.28	13/16	1.42	1.31	1.42
-T-C10-C6-C10	5/8	3/8	5/8	0.28	1	1.53	1.42	1.53
-T-C12-C6-C12	3/4	3/8	3/4	0.28	1 1/16	1.57	1.46	1.57
-T-C12-C8-C12	3/4	1/2	3/4	0.41	1 1/16	1.57	1.57	1.57
-T-C16-C6-C16	1	3/8	1	0.28	1 3/8	1.93	1.65	1.93
-T-C16-C8-C16	1	1/2	1	0.41	1 3/8	1.93	1.76	1.93
-T-C16-C12-C16	1	3/4	1	0.62	1 3/8	1.93	1.76	1.93
-T-C6-C6-C4	3/8	3/8	1/4	0.19	5/8	1.20	1.20	1.14
-T-C8-C6-C6	1/2	3/8	3/8	0.28	13/16	1.42	1.31	1.31
-T-C10-C6-C6	5/8	3/8	3/8	0.28	1	1.53	1.42	1.42
-T-C12-C6-C6	3/4	3/8	3/8	0.28	1 1/16	1.57	1.46	1.46
-T-C10-C6-C8	5/8	3/8	1/2	0.28	1	1.53	1.42	1.53
-T-C12-C6-C8	3/4	3/8	1/2	0.28	1 1/16	1.57	1.46	1.57
-T-C16-C6-C12	1	3/8	3/4	0.28	1 3/8	1.93	1.65	1.76

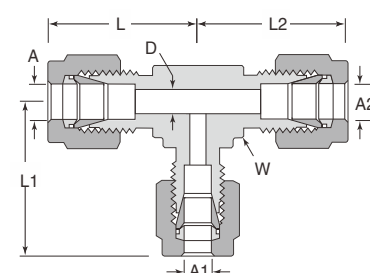

NPT外螺纹支管三通(英制)

基本订购号	导管外径A (in)	外螺纹T (NPT)	孔径D (in)	六角W (in)	长度L (in)	长度L1 (in)
-T-C2-T2-C2	1/8	1/8	0.09	7/16	0.93	0.70
-T-C2-T4-C2	1/8	1/4	0.09	1/2	0.97	0.92
-T-C3-T2-C3	3/16	1/8	0.12	7/16	0.96	0.70
-T-C4-T2-C4	1/4	1/8	0.19	1/2	1.06	0.74
-T-C4-T4-C4	1/4	1/4	0.19	1/2	1.06	0.92
-T-C5-T2-C5	5/16	1/8	0.19	5/8	1.17	0.82
-T-C6-T4-C6	3/8	1/4	0.28	5/8	1.20	1.00
-T-C6-T6-C6	3/8	3/8	0.28	13/16	1.31	1.11
-T-C8-T6-C8	1/2	3/8	0.38	13/16	1.42	1.11
-T-C8-T8-C8	1/2	1/2	0.41	13/16	1.42	1.30
-T-C10-T8-C10	5/8	1/2	0.47	1	1.53	1.41
-T-C12-T12-C12	3/4	3/4	0.62	1 1/16	1.57	1.45

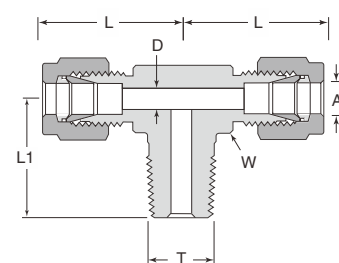

卡套管接头

NPT外螺纹支管三通(公制)

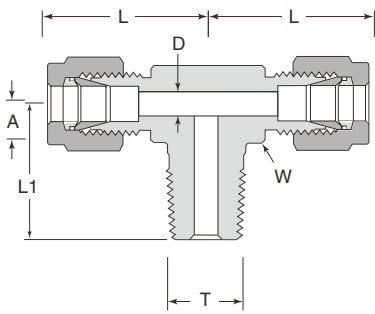

基本订购号	导管外径A (mm)	外螺纹T (NPT)	孔径D (mm)	六角W (in)	长度L (mm)	长度L1 (mm)
-T-C6M-T2-C6M	6	1/8	4.8	1/2	26.9	18.8
-T-C6M-T4-C6M	6	1/4	4.8	1/2	26.9	23.4
-T-C8M-T2-C8M	8	1/8	4.8	5/8	29.8	20.8
-T-C8M-T4-C8M	8	1/4	6.4	5/8	29.8	25.4
-T-C10M-T4-C10M	10	1/4	7.1	13/16	33.5	26.2
-T-C12M-T4-C12M	12	1/4	7.1	13/16	36.0	28.2
-T-C12M-T6-C12M	12	3/8	9.5	13/16	36.0	28.2
-T-C12M-T8-C12M	12	1/2	9.5	13/16	36.0	33.0
-T-C16M-T8-C16M	16	1/2	11.9	1	37.8	35.8

ISO/BSP锥形外螺纹支管三通

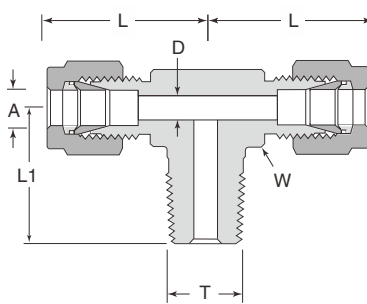

基本订购号	导管外径A (mm)	外螺纹T (R/BSPT)	孔径D (mm)	六角W (in)	长度L (mm)	长度L1 (mm)
-T-C6M-R2-C6M	6	1/8	4.8	1/2	26.9	18.8
-T-C6M-R4-C6M	6	1/4	4.8	1/2	26.9	23.4
-T-C8M-R2-C8M	8	1/8	4.8	5/8	29.8	20.8
-T-C8M-R4-C8M	8	1/4	6.4	5/8	29.8	25.4
-T-C10M-R4-C10M	10	1/4	7.1	13/16	33.5	26.2
-T-C12M-R4-C12M	12	1/4	7.1	13/16	36.0	28.2
-T-C12M-R6-C12M	12	3/8	9.5	13/16	36.0	28.2
-T-C12M-R8-C12M	12	1/2	9.5	13/16	36.0	33.0
-T-C16M-R8-C16M	16	1/2	11.9	1	37.8	35.8

NPT外螺纹侧三通(英制)

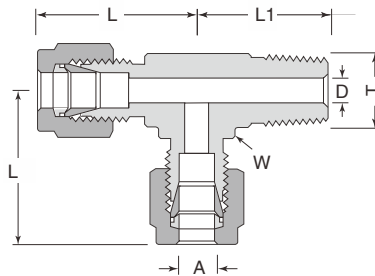

基本订购号	导管外径A (in)	外螺纹T (NPT)	孔径D (in)	六角W (in)	长度L (in)	长度L1 (in)
-T-C2-C2-T2	1/8	1/8	0.09	7/16	0.93	0.70
-T-C2-C2-T4	1/8	1/4	0.09	1/2	0.97	0.92
-T-C3-C3-T2	3/16	1/8	0.12	7/16	0.96	0.70
-T-C4-C4-T2	1/4	1/8	0.19	1/2	1.06	0.74
-T-C4-C4-T4	1/4	1/4	0.19	1/2	1.06	0.92
-T-C5-C5-T2	5/16	1/8	0.19	5/8	1.17	0.82
-T-C6-C6-T4	3/8	1/4	0.28	5/8	1.20	1.00
-T-C6-C6-T6	3/8	3/8	0.28	13/16	1.31	1.11
-T-C8-C8-T6	1/2	3/8	0.38	13/16	1.42	1.11
-T-C8-C8-T8	1/2	1/2	0.41	13/16	1.42	1.30
-T-C10-C10-T8	5/8	1/2	0.47	1	1.53	1.41
-T-C12-C12-T12	3/4	3/4	0.62	1 1/16	1.57	1.45

NPT外螺纹侧三通(公制)

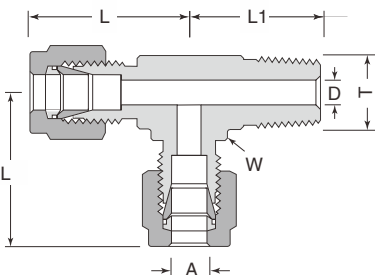

基本订购号	导管外径A (mm)	外螺纹T (NPT)	孔径D (mm)	六角W (in)	长度L (mm)	长度L1 (mm)
-T-C6M-C6M-T2	6	1/8	4.8	1/2	26.9	18.8
-T-C6M-C6M-T4	6	1/4	4.8	1/2	26.9	23.4
-T-C8M-C8M-T2	8	1/8	4.8	5/8	29.8	20.8
-T-C8M-C8M-T4	8	1/4	6.4	5/8	29.8	25.4
-T-C10M-C10M-T4	10	1/4	7.1	13/16	33.5	26.2
-T-C12M-C12M-T4	12	1/4	7.1	13/16	36.0	28.2
-T-C12M-C12M-T6	12	3/8	9.5	13/16	36.0	28.2
-T-C12M-C12M-T8	12	1/2	9.5	13/16	36.0	33.0
-T-C16M-C16M-T8	16	1/2	11.9	1	37.8	35.8

ISO/BSP锥形外螺纹侧三通

基本订购号	导管外径A (mm)	外螺纹T (R/BSPT)	孔径D (mm)	六角W (in)	长度L (mm)	长度L1 (mm)
-T-C6M-R2-C6M	6	1/8	4.8	1/2	26.9	18.8
-T-C6M-R4-C6M	6	1/4	4.8	1/2	26.9	23.4
-T-C8M-R2-C8M	8	1/8	4.8	5/8	29.8	20.8
-T-C8M-R4-C8M	8	1/4	6.4	5/8	29.8	25.4
-T-C10M-R4-C10M	10	1/4	7.1	13/16	33.5	26.2
-T-C12M-R4-C12M	12	1/4	7.1	13/16	36.0	28.2
-T-C12M-R6-C12M	12	3/8	9.5	13/16	36.0	28.2
-T-C12M-R8-C12M	12	1/2	9.5	13/16	36.0	33.0
-T-C16M-R8-C16M	16	1/2	11.9	1	37.8	35.8

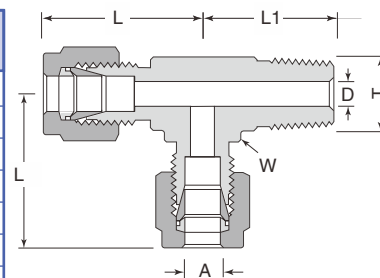

NPT内螺纹支管三通(英制)

基本订购号	导管外径A (in)	内螺纹T (NPT)	孔径D (in)	六角W (in)	长度L (in)	长度L1 (in)
-T-C2-TF2-C2	1/8	1/8	0.09	1/2	0.97	0.75
-T-C4-TF2-C4	1/4	1/8	0.19	1/2	1.06	0.75
-T-C4-TF4-C4	1/4	1/4	0.19	11/16	1.17	0.88
-T-C6-TF4-C6	3/8	1/4	0.28	11/16	1.23	0.88
-T-C6-TF6-C6	3/8	3/8	0.28	13/16	1.31	0.88
-T-C6-TF8-C6	3/8	1/2	0.28	1	1.42	1.12
-T-C8-TF4-C8	1/2	1/4	0.41	13/16	1.42	0.88
-T-C8-TF6-C8	1/2	3/8	0.41	13/16	1.42	0.88
-T-C8-TF8-C8	1/2	1/2	0.41	1	1.53	1.12
-T-C10-TF8-C10	5/8	1/2	0.50	1	1.53	1.12
-T-C12-TF12-C12	3/4	3/4	0.62	1 3/8	1.76	1.25

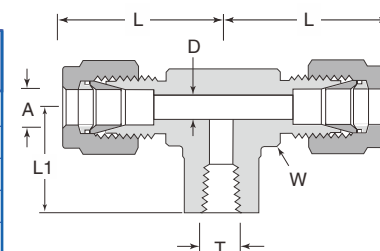

NPT内螺纹支管三通(公制)

基本订购号	导管外径A (mm)	内螺纹T (NPT)	孔径D (mm)	六角W (in)	长度L (mm)	长度L1 (mm)
-T-C6M-TF2-C6M	6	1/8	4.8	1/2	26.9	19.0
-T-C6M-TF4-C6M	6	1/4	4.8	11/16	29.7	22.4
-T-C8M-TF2-C8M	8	1/8	6.4	5/8	29.8	19.0
-T-C8M-TF4-C8M	8	1/4	6.4	11/16	30.6	22.4
-T-C10M-TF4-C10M	10	1/4	7.9	13/16	33.5	22.4
-T-C12M-TF4-C12M	12	1/4	9.5	13/16	36.0	22.4
-T-C12M-TF6-C12M	12	3/8	9.5	13/16	36.0	22.4
-T-C12M-TF8-C12M	12	1/2	9.5	1	38.8	28.4
-T-C16M-TF8-C16M	16	1/2	12.7	1	38.8	28.4

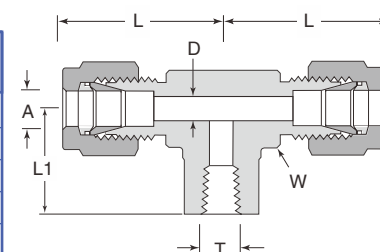

ISO/BSP锥形内螺纹支管三通

基本订购号	导管外径A (mm)	内螺纹T (R/BSPT)	孔径D (mm)	六角W (in)	长度L (mm)	长度L1 (mm)
-T-C6M-RC2-C6M	6	1/8	4.8	1/2	26.9	19.0
-T-C6M-RC4-C6M	6	1/4	4.8	11/16	29.7	22.4
-T-C8M-RC2-C8M	8	1/8	6.4	5/8	29.8	19.0
-T-C8M-RC4-C8M	8	1/4	6.4	11/16	30.6	22.4
-T-C10M-RC4-C10M	10	1/4	7.9	13/16	33.5	22.4
-T-C12M-RC4-C12M	12	1/4	9.5	13/16	36.0	22.4
-T-C12M-RC6-C12M	12	3/8	9.5	13/16	36.0	22.4
-T-C12M-RC8-C12M	12	1/2	9.5	1	38.8	28.4
-T-C16M-RC8-C16M	16	1/2	12.7	1	38.8	28.4

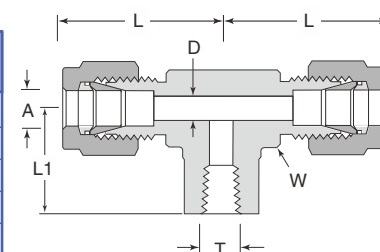

卡套管接头

NPT内螺纹侧三通(英制)

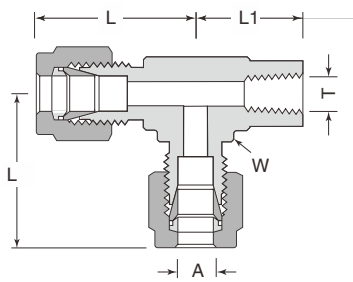

基本订购号	导管外径A (in)	内螺纹T (NPT)	孔径D (in)	六角W (in)	长度L (in)	长度L1 (in)
-T-C2-C2-TF2	1/8	1/8	0.09	1/2	0.97	0.75
-T-C4-C4-TF2	1/4	1/8	0.19	1/2	1.06	0.75
-T-C4-C4-TF4	1/4	1/4	0.19	11/16	1.17	0.88
-T-C6-C6-TF4	3/8	1/4	0.28	11/16	1.23	0.88
-T-C6-C6-TF6	3/8	3/8	0.28	13/16	1.31	0.88
-T-C6-C6-TF8	3/8	1/2	0.28	1	1.42	1.12
-T-C8-C8-TF4	1/2	1/4	0.41	13/16	1.42	0.88
-T-C8-C8-TF6	1/2	3/8	0.41	13/16	1.42	0.88
-T-C8-C8-TF8	1/2	1/2	0.41	1	1.53	1.12
-T-C10-C10-TF8	5/8	1/2	0.50	1	1.53	1.12
-T-C12-C12-TF12	3/4	3/4	0.62	1 3/8	1.76	1.25

NPT内螺纹侧三通(公制)

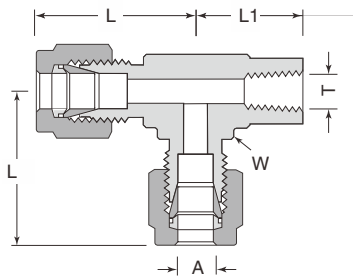

基本订购号	导管外径A (mm)	内螺纹T (NPT)	孔径D (mm)	六角W (in)	长度L (mm)	长度L1 (mm)
-T-C6M-C6M-TF2	6	1/8	4.8	1/2	26.9	19.0
-T-C6M-C6M-TF4	6	1/4	4.8	11/16	29.7	22.4
-T-C8M-C8M-TF2	8	1/8	6.4	5/8	29.8	19.0
-T-C8M-C8M-TF4	8	1/4	6.4	11/16	30.6	22.4
-T-C10M-C10M-TF4	10	1/4	7.9	13/16	33.5	22.4
-T-C12M-C12M-TF4	12	1/4	9.5	13/16	36.0	22.4
-T-C12M-C12M-TF6	12	3/8	9.5	13/16	36.0	22.4
-T-C12M-C12M-TF8	12	1/2	9.5	1	38.8	28.4
-T-C16M-C16M-TF8	16	1/2	12.7	1	38.8	28.4

ISO/BSP锥形内螺纹侧三通

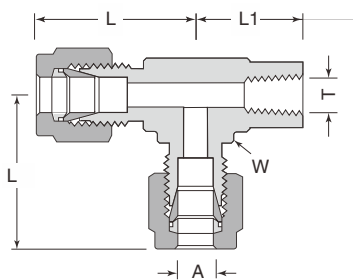

基本订购号	导管外径A (mm)	内螺纹T (R/BSPT)	孔径D (mm)	六角W (in)	长度L (mm)	长度L1 (mm)
-T-C6M-C6M-RC2	6	1/8	4.8	1/2	26.9	19.0
-T-C6M-C6M-RC4	6	1/4	4.8	11/16	29.7	22.4
-T-C8M-C8M-RC2	8	1/8	6.4	5/8	29.8	19.0
-T-C8M-C8M-RC4	8	1/4	6.4	11/16	30.6	22.4
-T-C10M-C10M-RC4	10	1/4	7.9	13/16	33.5	22.4
-T-C12M-C12M-RC4	12	1/4	9.5	13/16	36.0	22.4
-T-C12M-C12M-RC6	12	3/8	9.5	13/16	36.0	22.4
-T-C12M-C12M-RC8	12	1/2	9.5	1	38.8	28.4
-T-C16M-C16M-RC8	16	1/2	12.7	1	38.8	28.4

卡套四通接头(英制)

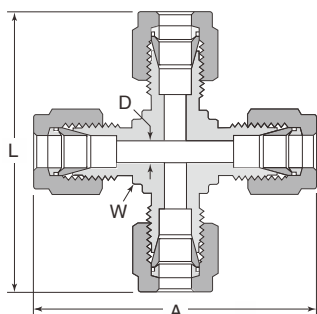

基本订购号	导管外径A (in)	孔径D (in)	六角W (in)	长度L (in)
-H-C2	1/8	0.09	3/8	1.76
-H-C4	1/4	0.19	1/2	2.12
-H-C5	5/16	0.25	5/8	2.34
-H-C6	3/8	0.28	5/8	2.40
-H-C8	1/2	0.41	13/16	2.84
-H-C12	3/4	0.62	1 1/16	3.14
-H-C16	1	0.88	1 3/8	3.86

卡套四通接头(公制)

基本订购号	导管外径A (mm)	孔径D (mm)	六角W (in)	长度L (mm)
-H-C3M	3	2.4	3/8	44.7
-H-C6M	6	4.8	1/2	53.9
-H-C8M	8	6.4	5/8	59.7
-H-C10M	10	7.9	13/16	67.0
-H-C12M	12	9.5	13/16	72.0
-H-C16M	16	12.7	15/16	74.0
-H-C18M	18	15.1	1 1/16	76.6
-H-C20M	20	15.9	1 3/8	89.3
-H-C22M	22	18.3	5/8	89.4
-H-C25M	25	21.8	1 3/8	98.3

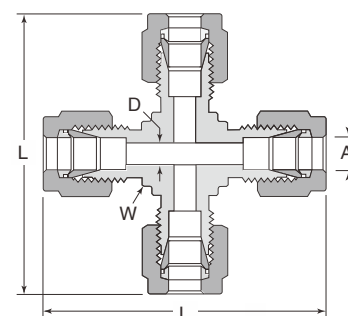

卡套转法兰接头(DIN)

基本订购号	导管外径A (mm)	法兰规格 (DN)	孔距J (mm)	外径B (mm)	孔径D (mm)	六角W (in)	长度L (mm)
-U-C6M-FL25M	6	25	85.0	115	4.8	20	47.5
-U-C12M-FL15M	12	15	65.0	95.0	9.5	20	48.5
-U-C12M-FL25M	12	25	85.0	115	9.5	20	50.5
-U-C12M-FL50M	12	50	125	165	9.5	20	55.3
-U-C18M-FL15M	18	15	65.0	95.0	15.1	32	51.8
-U-C18M-FL25M	18	25	85.0	115	15.1	32	53.8
-U-C25M-FL25M	25	25	85.0	115	21.8	35	64.0

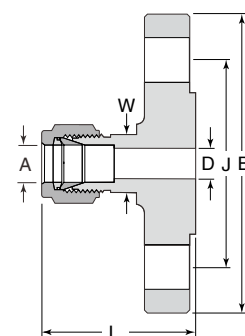

卡套转法兰接头(JIS)

基本订购号	导管外径A (in)	法兰规格 (DN)	孔距J (in)	外径B (in)	孔径D (in)	六角W (in)	长度L (in)
-U-C4-FL15M	1/4	15	2.76	3.74	0.19	13/16	1.66
-U-C6-FL15M	3/8	15	2.76	3.74	0.28	13/16	1.72
-U-C8-FL15M	1/2	15	2.76	3.74	0.41	13/16	1.83
-U-C12-FL15M	3/4	15	2.76	3.74	0.62	1 1/4	1.91
-U-C16-FL25M	1	25	3.54	4.92	0.88	1 3/8	2.40

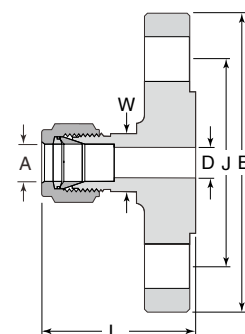

卡套转卫生级法兰接头

基本订购号	导管外径A (in)	法兰规格 (in)	孔距J (in)	外径B (in)	孔径D (in)	六角W (in)	长度L (in)
-U-C4-VS8	1/4	1/2	0.37	0.98	0.19	1	1.57
-U-C4-VS12	1/4	3/4	0.62	0.98	0.19	1	1.57
-U-C4-VS16	1/4	1	0.87	1.98	0.19	1 3/8	1.57
-U-C4-VS24	1/4	1 1/2	1.37	1.98	0.19	1 3/8	1.57
-U-C6-VS8	3/8	1/2	0.37	0.98	0.28	1	1.63
-U-C6-VS12	3/8	3/4	0.62	0.98	0.28	1	1.63
-U-C6-VS16	3/8	1	0.87	1.98	0.28	1 3/8	1.63
-U-C6-VS24	3/8	1 1/2	1.37	1.98	0.28	1 3/8	1.63
-U-C8-VS8	1/2	1/2	0.37	0.98	0.37	1	1.74
-U-C8-VS12	1/2	3/4	0.62	0.98	0.41	1	1.74
-U-C8-VS16	1/2	1	0.87	0.98	0.41	1 3/8	1.74
-U-C8-VS24	1/2	1 1/2	1.37	0.98	0.41	1 3/8	1.74
-U-C16-VS16	1	1	0.87	0.98	0.87	1 3/8	1.91
-U-C16-VS32	1	2	1.37	2.52	0.88	2 3/4	2.49

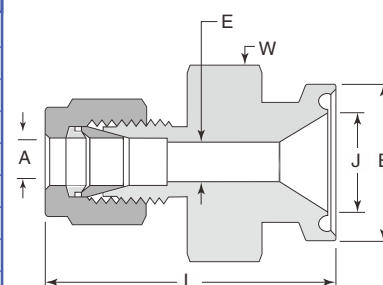

卡套管接头

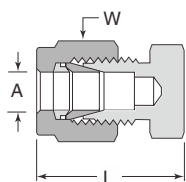

管堵(公制)

基本订购号	导管外径A (mm)	六角W (mm)	长度L (mm)
-GD2M	2	12	20.1
-GD3M	3	12	20.1
-GD4M	4	12	21.3
-GD6M	6	14	23.1
-GD8M	8	16	24.5
-GD10M	10	19	26.6
-GD12M	12	22	29.1
-GD14M	14	25	29.9
-GD15M	15	25	29.9
-GD16M	16	25	29.9
-GD18M	18	30	31.4
-GD20M	20	32	34.0
-GD22M	22	32	34.0
-GD25M	25	38	38.5

管堵(英制)

基本订购号	导管外径A (in)	六角W (in)	长度L (in)
-GD1	1/16	5/16	0.59
-GD2	1/8	7/16	0.79
-GD3	3/16	1/2	0.84
-GD4	1/4	9/16	0.92
-GD5	5/16	5/8	0.96
-GD6	3/8	11/16	1.01
-GD8	1/2	7/8	1.15
-GD10	5/8	1	1.18
-GD12	3/4	1 1/8	1.24
-GD14	7/8	1 1/4	1.34
-GD16	1	1 1/2	1.51

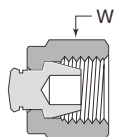

卡套堵头(公制)

基本订购号	导管外径A (mm)	六角W (mm)
-GM2M	2	12
-GM3M	3	12
-GM4M	4	12
-GM6M	6	14
-GM8M	8	16
-GM10M	10	19
-GM12M	12	22
-GM14M	14	25
-GM15M	15	25
-GM16M	16	25
-GM18M	18	30
-GM20M	20	32
-GM22M	22	32
-GM25M	25	38

卡套堵头(英制)

基本订购号	导管外径A (in)	六角W (in)
-GM1	1/16	5/16
-GM2	1/8	7/16
-GM3	3/16	1/2
-GM4	1/4	9/16
-GM5	5/16	5/8
-GM6	3/8	11/16
-GM8	1/2	7/8
-GM10	5/8	1
-GM12	3/4	1 1/8
-GM14	7/8	1 1/4
-GM16	1	1 1/2

北京尼克福斯阀门科技有限责任公司

地址:北京市大兴区丽园路港悦大厦7号楼1101
电话:86-010-66117795
传真:86-010-63733307 网址:www.nikfus.cn
邮编:100071 邮箱:sale1@nikfus.com

沧州尼克福斯仪表有限公司

地址:河北省沧州市南皮工业区
手机:13811443727 (微信同号)
邮编:061599 网址:www.nikfus.cn